

European Centre for Medium Range Weather Forecasts

ECMWF NEWSLETTER

Shinfield Park, Reading, Berkshire RG2 9AX, England. Tel: U.K. (0734) 876000, Int. (44 734) 876000, Telex: 847908

Number 30 - June 1985

NOAA-6 7FEB 1985 12Z TOVS/SATEM

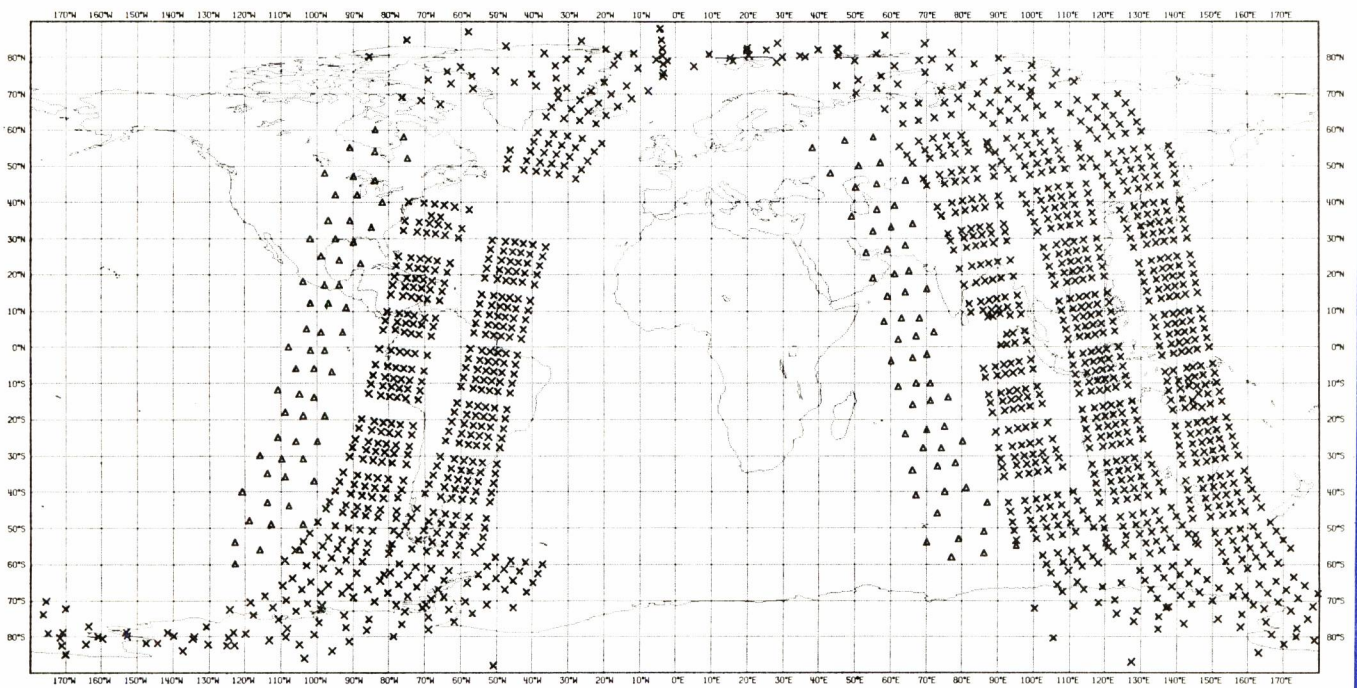

IN THIS ISSUE**METEOROLOGICAL**

Changes to the ECMWF operational forecasting system	2
Use of high resolution SATEMS in the operational analysis	3
First operational experience with filtered forecast fields at SMHI	6
Chinese meteorological studies at ECMWF	9
ECMWF Workshop: Nov. 1984: Use and quality control of meteorological observations for numerical weather predictions	13

COMPUTING

The ECMWF CRAY X-MP/48	15
------------------------	----

COMPUTER USER INFORMATION

Still valid news sheets	19
Removing magnetic tapes from the Centre's tape library	19

GENERAL

1985 ECMWF Seminar: Physical parameterisation for numerical models of the atmosphere (Sept. 1985)	20
ECMWF publications	21
Calendar of events at ECMWF	21
The Centre's 10th anniversary celebrations	21
Index of still valid newsletter articles	22

COVER: The cover illustration shows satellite data from NOAA-6 for 12Z on 7 February 1985. TOVS were included when available, otherwise SATEMS were used (Δ = SATEMS, X = TOVS). (See article on page 3).

This Newsletter is edited and produced by User Support.

The next issue will appear in June 1985.

The new T106 version of the forecast model was successfully introduced into operation on 1 May 1985, and an initial summary of its performance is given on page 2. A full report will be given in the next issue of the Newsletter (September 1985).

The Centre always welcomes reports from national meteorological services on their experience with ECMWF forecasts, particularly when a new experimental forecast product has been included in the range for dissemination. On page 6 an article describes Sweden's encouraging experience with products truncated at spectral component T10.

At the 21st session of Council (8-9 May 1985), a proposal to replace the Centre's present CRAY X-MP/22 with a CRAY X-MP/48 was approved. Consequently, at the end of this year, the Centre will install a CRAY X-MP/48, with the primary aim of providing the additional resources necessary to fulfil the Centre's planned programme of research from the end of 1986 onwards. Details of the machine, and of the performance trials undertaken by ECMWF to ascertain the potential benefit to be gained from the new machine for the Centre's particular research and operational purposes, are given on page 15.

* * * * *

CHANGES TO THE ECMWF OPERATIONAL FORECASTING SYSTEM

Recent Changes

- (i) The new high resolution forecast model (T106) was implemented successfully on 1 May 1985. Details of the new model can be found in Newsletter No. 29, page 3.
- (ii) Also on 1 May, changes to the physical parameterisation scheme were introduced operationally, including the addition of a treatment of shallow convection, a modification of the Kuo convection scheme and the large scale condensation and a new representation of clouds.

A first evaluation of the performance of the new model based on the period of the 'parallel run' (11 to 30 April) and the first days in May can be summarised as follows:

1. For the European area, a consistent improvement in the objective scores of the anomaly correlation and RMS error of height was found out to day 5, particularly for the lower part of the troposphere. Note also that the negative mean error of height appears to be reduced over Europe.
2. An improved treatment of synoptic scale features, such as intense lows, frontal zones, anticyclones and ridges was found in the first half of the forecast. However, the weather systems also appear to be more active at the later stage of the forecast and this, on occasions, can lead to a deterioration in objective verification results when the long wave pattern is out of phase.
3. The high resolution and the new physics gave improved forecasts of some near surface weather parameters. The diurnal cycle in the locally predicted cloud amount is now more realistic, the wind speed at 10 m above the model surface, which was partly overestimated over land in the old model, has been reduced.

However, preliminary verification results for May indicate that the model predicted rainfall is still positively biased over large parts of Europe. The day time temperature at 2 m often appears to be underestimated by some degrees particularly in northern and eastern parts of Europe.

Planned changes

No further major changes are planned for this coming quarter. However, minor modifications may be introduced as necessary to reduce biases in the forecasts of near-surface parameters produced by the new model.

- Horst Böttger

* * * * *

USE OF HIGH RESOLUTION SATEMS IN THE OPERATIONAL ANALYSIS

The ECMWF operational analysis system originally used satellite observations (SATEMS) transmitted on the GTS with a 500 km resolution. However, satellite observations with a 250 km resolution, known as TOVS, are also transmitted from Washington to Reading via WMO RTH Bracknell. TOVS were at first discarded from the operational analysis but recent experiments have investigated the usefulness of their inclusion. The results of these experiments led to the inclusion of TOVS in the operational analysis with effect from 26 February 1985.

Basically, the SATEMS should be a simple subset of TOVS, and so, ideally, we should discard the SATEMS and use the TOVS. However, in reality, there are telecommunications delays, and so it occasionally happens that the SATEMS are available for the analysis while some, or all, TOVS are missing. Therefore, the correct way to use satellite information is to include both the TOVS and SATEMS, but discard any SATEMS which are collocated with TOVS. In other words, use the TOVS when they are available, and the SATEMS when they are not. To illustrate this, Fig. 1 shows the satellite data from NOAA-6 which would be used in the analysis for 12Z 2 February, when this approach is adopted. Note that due to transmission problems there are gaps in the TOVS coverage.

The main advantage of using TOVS rather than SATEMS is their higher horizontal resolution. There are, however, two other differences in the form of the data which may be important for the analysis:

- a) the SATEM information is given in dam, while in TOVS it is given in tenths of a degree; thus the rounding errors in calculating mean temperatures are negligible for the TOVS, but not for the SATEMS. For example, in the 850/700 mb thicknesses computed from the 1000/700 mb and 1000/850 mb SATEM thicknesses, the rounding error could reach 10 metres, which corresponds to an approximately 2°C error in the 850/700 mb mean temperature. The corresponding rounding error for the TOVS is negligible.
- b) In the SATEM code the observation time is rounded to the nearest hour, while in the TOVS code the time is given to the nearest minute. This means, for example, that the present 12Z analysis uses SATEM from 09.30 to 15.29.

A data assimilation experiment was run for a 2-day period (12Z 5-7 February 1985) using the following modifications:

- a) TOVS were included.
- b) The maximum number of observations used in the optimum interpolation for one analysis box was increased from 191 to 255.
- c) Slight changes were introduced into the data selection.

Unfortunately, an instrument problem occurred on NOAA-7 on the evening of 5 February, giving some gaps in the NOAA-7 data coverage during the whole period; this problem may also have affected the quality of the soundings. Clearly, the experiments to assess the impact of TOVS compared with SATEMS should be repeated when NOAA-9 becomes operational.

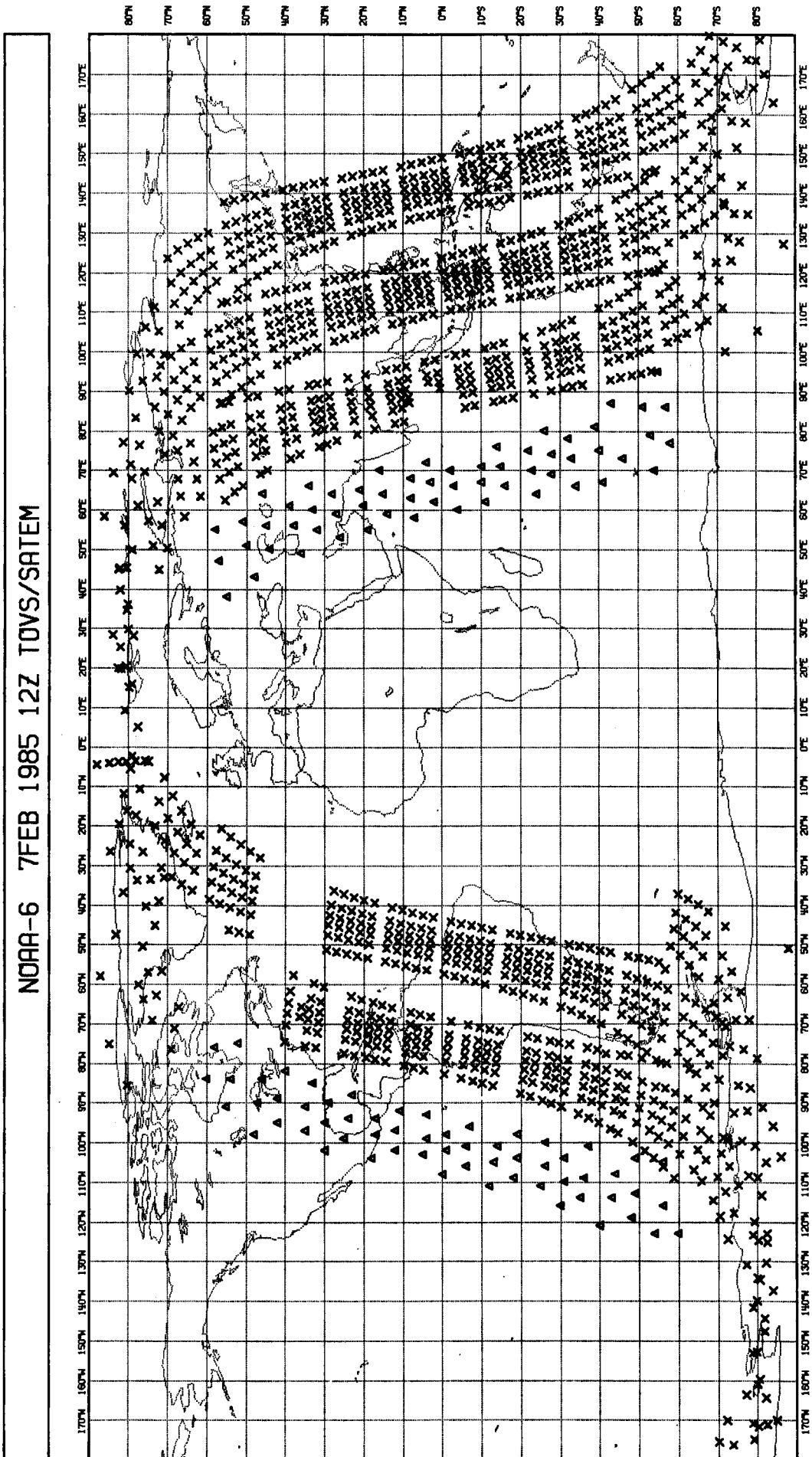

Δ - SATEMS
X - TOVS

Fig. 1: Satellite data from NOAA-6 for 12Z 7 February 1985 when TOVS are included when they are available and SATEMS when they are not.

The experimental results have been compared with those from the operational data assimilation scheme. Fig. 2 shows that the 6-hour forecast (guess-field) fits the SATEM data more closely when the TOVS are used - this is especially apparent in the Southern Hemisphere. The corresponding differences of the fits to the radiosonde data are very small in the Northern Hemisphere, though in the Southern Hemisphere the TOVS bring about a small improvement. The small impact is not surprising since the satellite data are not used over the continents in the troposphere, and most of the radiosondes are over the continents: a forecast of more than 6-hours is required to carry TOVS information from the oceans to the continents. These results indicate a slight improvement in the 6-hour forecast, though no important differences are apparent from a subjective assessment of the analyses. Also there appears to be no significant impact on 6-day forecasts, even in the Southern Hemisphere.

Although the improvement in the analysis and forecast is very small, the modifications were introduced into operations on 26 February 1985. This will then be the first step in the modification of the operational use of satellite data. The other planned developments are:

- a) use of 11 thicknesses instead of 14 in the vertical;
- b) tuning of the satellite observation error statistics;
- c) exclusion of potentially redundant SATEMS;
- d) investigation of the impact of off-time TOVS;
- e) possible use of SATEMS over land.

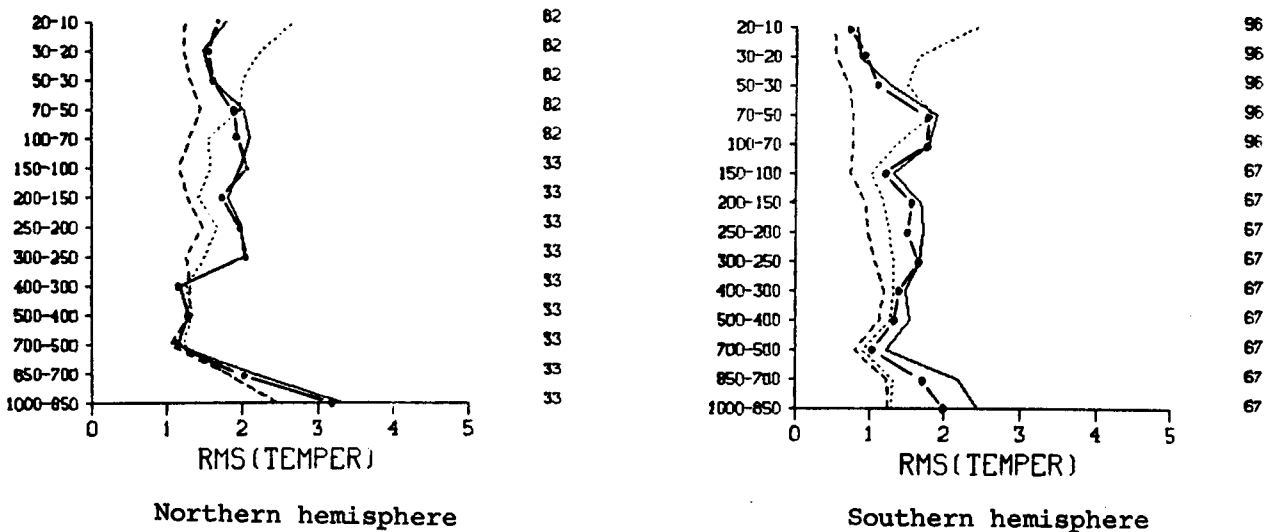

Fig. 2: RMS fit of SATEM observations to the first guess
 — operations) for 12 GMT 6 February 1985
 - - - - TOVS in)
 analysis)
 initialisation) for 12 GMT 6 February 1985

- Jean Pailleux, Johannes Andersen

* * * * *

FIRST OPERATIONAL EXPERIENCE WITH FILTERED FORECAST FIELDS AT SMHI

Filtered ECMWF products of 500 and 1000 mb geopotential fields and 850 mb temperature anomalies were used at the Swedish Meteorological Service (SMHI) during the winter 1984-85 for forecasts of mean temperature and wind direction out to 10 days provided for the Swedish icebreaking service.

The staff of the Marine Forecasting Service at SMHI also consulted the products. They made use of them in their daily conferences with the central command of the Icebreaking Navy. The marine meteorologists, who only made qualitative forecasts, claim that the charts have enabled them to extend their guidance 1-2 days further (up to a week) than by using only non-filtered fields.

Twice a week, in total on 46 occasions, quantitative 6-10 day forecasts of mean temperature and wind direction were issued by the medium range section at SMHI. They are normally provided with a statistical interpretation of the ECMWF forecast (extended 36 hours by pure persistence). On 10 occasions filtered forecast fields were provided and carefully synoptically evaluated. In all cases this also included comparisons with the preceding 2 or 3 forecast runs. On 36 occasions filtered maps were either not available or were not used by the forecaster. The forecasts were later verified in an objective scheme where 1.0 means a perfect forecast, 0.5 a climatological guess.

Compared to the forecasts based on statistical interpretation, the temperature forecasts based on non-filtered products only improved by 0.04 (0.58 to 0.62), compared to an increase of 0.12 when filtered fields were also used. The forecasters using non-filtered fields did not improve the scores of the wind forecast (0.60). When filtered fields were used the scores rose slightly by 0.04. These improvements correspond to an increase in predictability of between one and two days.

An interesting case developed early in March this year. During this cold winter most of the waters between Finland and Sweden froze to a greater extent than normal. Steady southeasterly winds during the last days of February and early March (Fig. 1) pressed the ice towards the Swedish east coast while it left a channel of open water outside the Finnish coast. The situation was very critical. If the wind changed to a westerly direction, the ice would drift eastwards and the conditions along the Swedish coast would improve. On the Finnish side, however, the situation would worsen and the ships would run the risk of being blocked in.

On Tuesday 5 March the ECMWF forecast (4/3 12Z, (Fig. 2c)) indicated that the Swedish-Finnish waters should, after six days, experience westerly winds. The icebreakers were made aware of this change in the winds the same day and preparations started immediately to divert the traffic coming up from the south. The forecast was followed up during the subsequent days, and when the change in wind direction took place during the weekend the icebreakers were in their new positions and the ship traffic continued to move smoothly.

On 5 March and the previous days, filtered ECMWF charts had, for technical reasons, been unavailable. When the charts from 2-4 March were plotted some days later and presented to the marine meteorologists on duty, they noted that the shift in winds could have been foreseen at least one day earlier, had filtered maps been available.

In the ECMWF forecast from 2 March (Fig. 2a) it can be seen how the low pressure system over the Atlantic moves northeastwards while the high pressure over Russia moves westwards and/or extends a ridge of high pressure down to Central Europe. This general development weakens the southeasterly gradient over Scandinavia and opens up the possibility of a westerly gradient over the northernmost parts.

In the ECMWF forecast from the next day (Fig. 2b) the same development was indicated and confirmed the forecast from the day before. The shift from southeasterly to westerly wind a week later is now clear.

Already at this stage there would have been grounds for issuing a warning to the Swedish icebreaking service that a change would take place a week later. Only the next day (Fig. 2c) this change became obvious and trustworthy, when the non-filtered and filtered ECMWF forecasts were evaluated.

D + 1 VALID 85/03/03

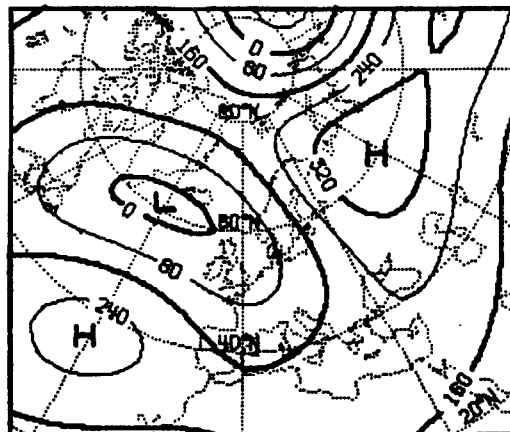
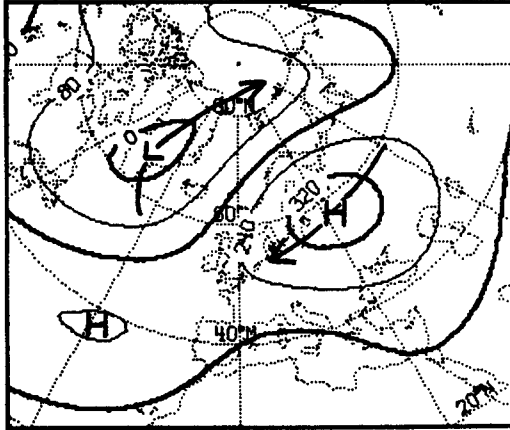

Fig. 1: 24 hr forecast of 1000 mb height filtered at T10 valid 3 March 1985 1200 GMT, units in metres.

D + 8 VALID 85/03/10



(a)

D + 7 VALID 85/03/10

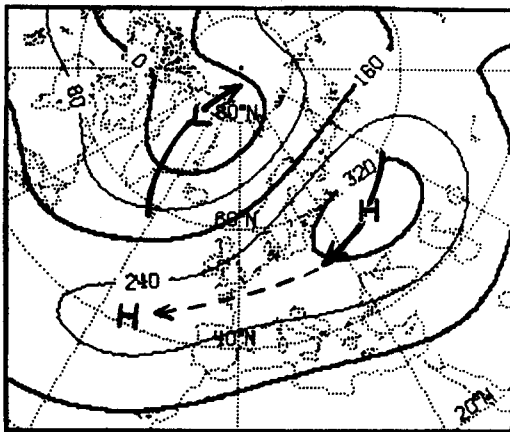

(b)

Fig. 2:
 192 hr (a) of 2 March, 168 hr (b) of 3 March and 144 hr (c) forecast of 4 March 1985 of 1000 mb height filtered at T10, all valid on 10 March 1985 1200 GMT; units in metres.

D + 6 VALID 85/03/10

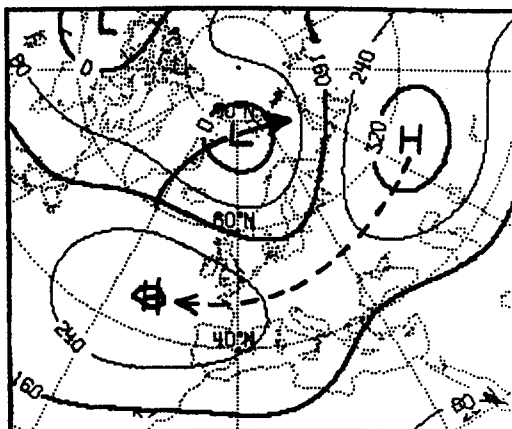

(c)

- Anders Persson
S M H I

CHINESE METEOROLOGICAL STUDIES AT ECMWF

In recent years several Chinese meteorologists have visited the Centre for extended periods. They arrived with enormous enthusiasm and a prodigious capacity for work. Then, infected by their enthusiasm, some of the Centre's staff also gradually became involved in trying to understand the many varied and unusual meteorological phenomena which occur over China. Many of these are associated with the dynamic and thermal effects of the Qinghai-Tibet-Plateau (QTP).

The QTP is the largest plateau on earth; it covers a very large area, as seen in Fig. 1, and its mean height is such that the 500 mb isobaric surface is only about 1 km above the Plateau. Therefore, this plateau can have far reaching effects on the atmospheric flow - it can influence both the mid-latitude westerlies and the monsoon flow, and the positions of the Western Pacific high and the Aleutian low. During the winter, when the polar jet moves southwards, its interaction with the northern edge of the QTP can be of great importance for the medium range forecasts: an incorrect representation of the mountains can lead to forecast errors which travel eastwards, amplify and within a few days affect the prediction over North America and Europe.

The QTP exerts both dynamic and thermal effects on the atmosphere. During summer, the atmosphere over the plateau is super-moist adiabatic below 400 mb, and the region is as convectively active as the tropical oceans. When the south-west monsoon is sufficiently strong to travel over the Himalayas and invade the QTP, and a cold westerly trough moves across the northern part of the plateau, vortices can develop in the confluence zone; these vortices are characteristic features of the meteorology of the Plateau. They can intensify rapidly and move eastwards. Then a pronounced south-west low-level jet forms on the eastern side of the vortex and heavy rainfall (of the order of 100 mm per day) occurs, and sometimes causes extremely damaging flooding over the provinces of south-west China. The ability of the Centre's model to reproduce this kind of circulation was tested and it was found that great improvements can be achieved by increasing the horizontal resolution and thus the accuracy of the orographic representation. This can be seen, for instance, by comparing the low and high resolution forecasts of the development of the vortex over the QTP with the analysis (Fig. 2). However, the relationship between latent heat release and resolution over complex orographies like the Plateau needs to be investigated further, in order to avoid overprediction of wind and precipitation.

In winter, the subtropical jet-stream and the polar jet-stream merge over the East Asian continent. Due to the confluence of these large scale flows, a few well developed cyclones form over Mongolia and north-east China. Over the mainland, many of these cyclones appear as flat lows or inverted troughs. However, if such weak disturbances move off the coast, they can deepen very quickly with a drop of pressure of more than 20 mb in 24 hours. The cyclones which develop over the Yellow and East Seas often cause strong gales, then, as they continue to deepen, they move north-eastward and eventually become huge lows over the Aleutian region, which may affect the general circulation.

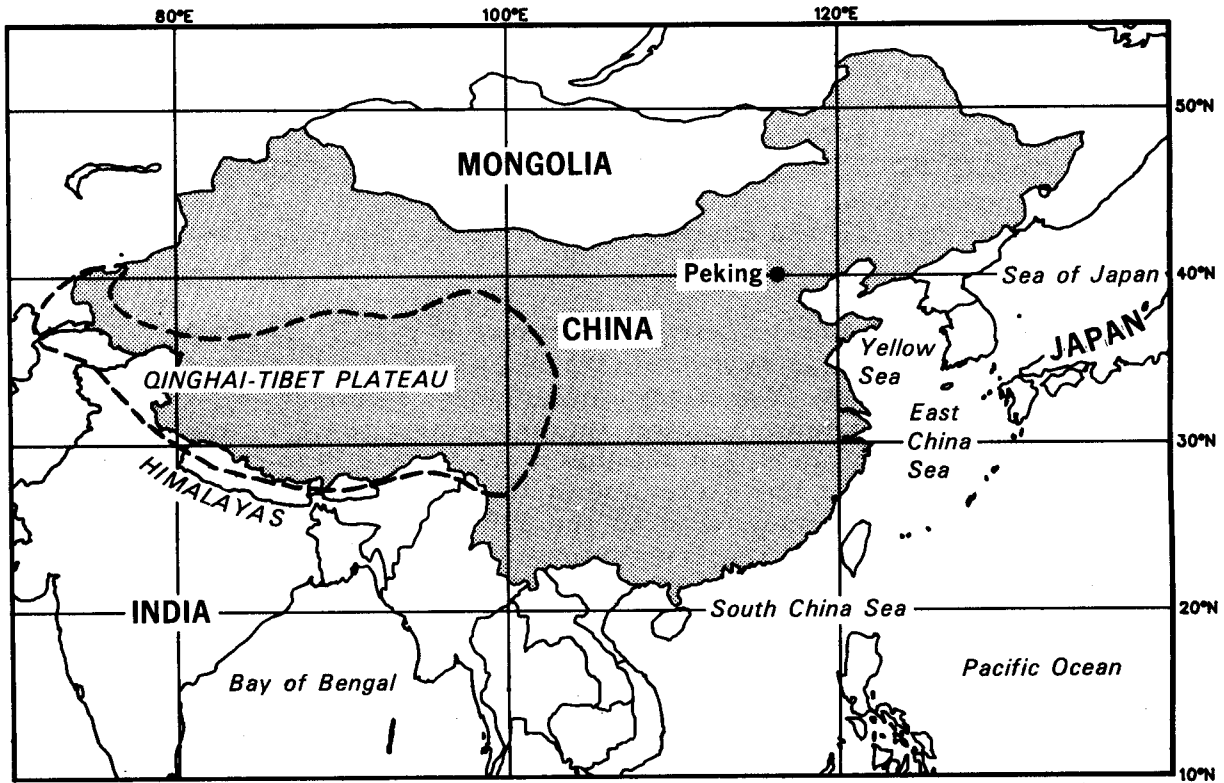

Fig. 1: The Qinghai-Tibet Plateau

An example of this kind of development is given in Fig. 3. Initially, an anticyclonic circulation occupies the southern part of the mainland and a cold-high over the western Pacific, with the cold front ahead of it, extends from Okinawa Island to South China. As the upper trough approaches the weak surface inverted trough, the cyclone starts to form and deepens extremely quickly.

Due to the great importance of diabatic forcing in these and similar phenomena that occur over the Chinese continent, experiments to analyse their nature, conducted at the Centre, are valuable for investigating the physical processes involved and the possibility of simulating them in the Centre's model.

- Lorenzo Dell'Osso

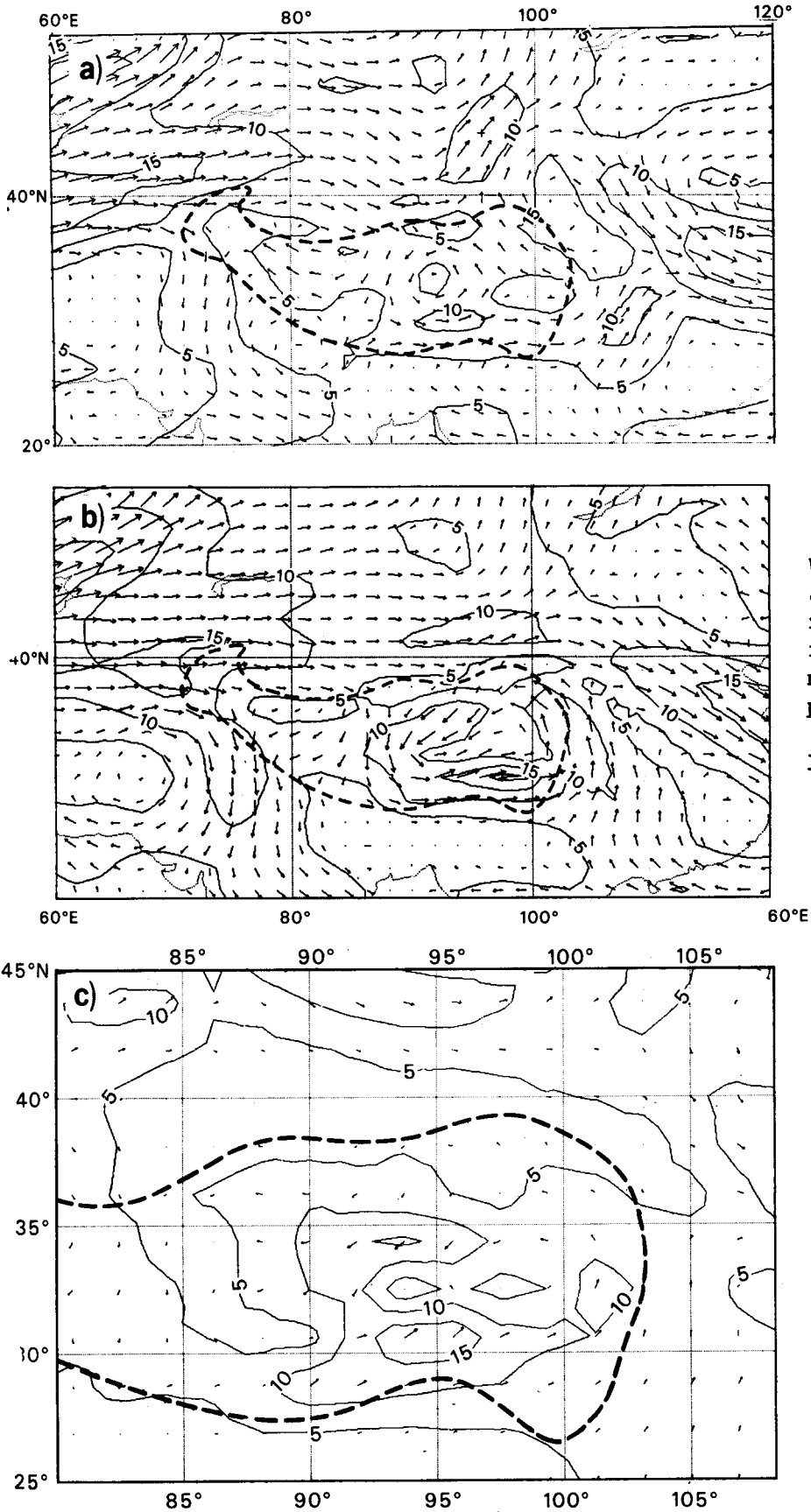

Fig. 2:

Wind field at 500 mb for the
a) analysis and for the 48 hr
forecast with the b) N48
resolution and c) N192 resolution
model. The N192 results are inter-
polated over squares of 16 points.
(Isotachs every 5 m; the dashed
line is the 3000 m height contour)

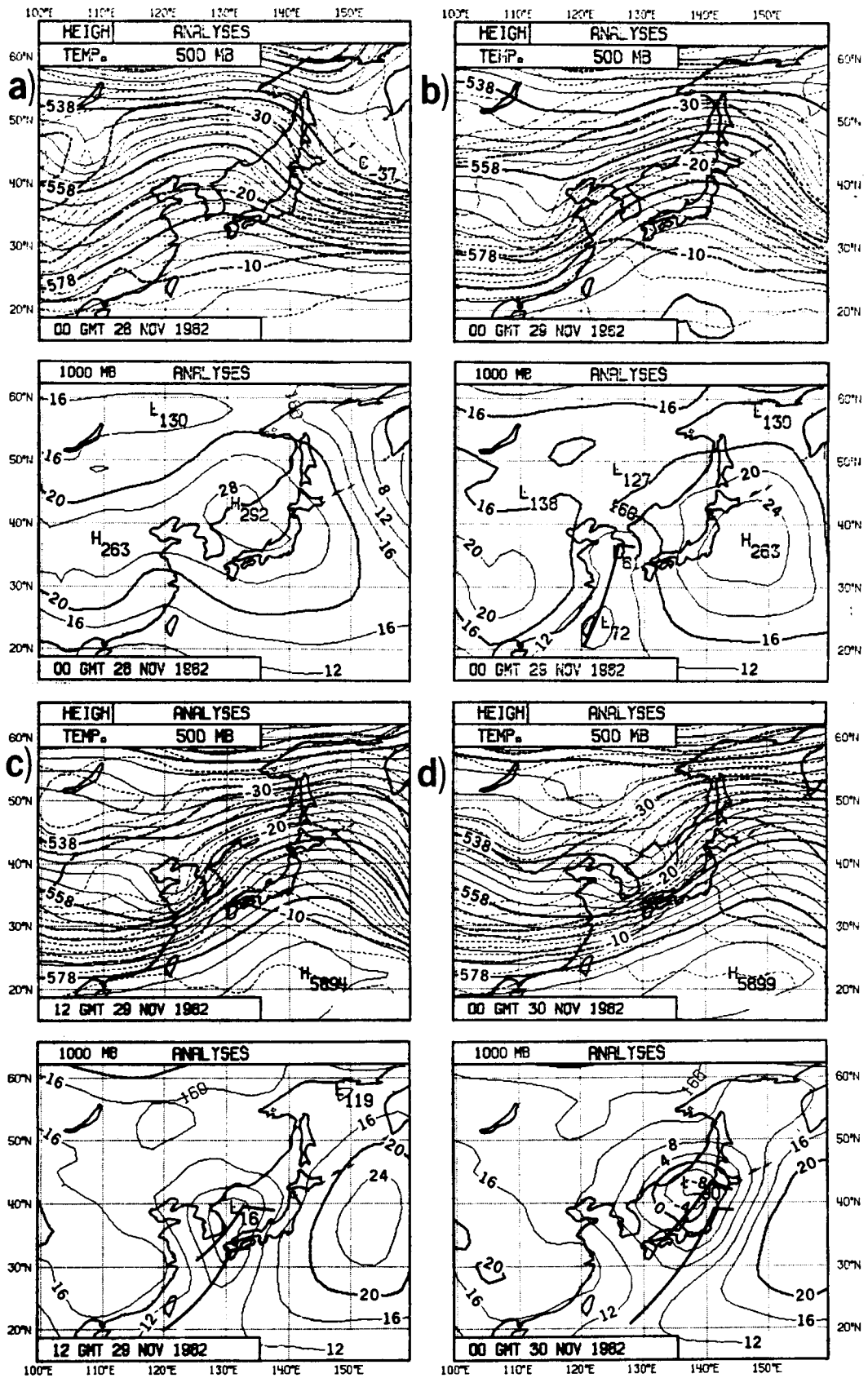

Fig. 3: Analysed geopotential height (solid lines) at 500 and 1000 mb and temperature (dashed lines) for a) 00GMT 28, b) 00GMT 29, c) 12GMT 29, and d) 00GMT 30 November 1982. Units in dam and °C.

ECMWF WORKSHOP, 6-9 NOVEMBER 1984USE AND QUALITY CONTROL OF METEOROLOGICAL OBSERVATIONS
FOR NUMERICAL WEATHER PREDICTIONS

There is good evidence that the quality of data assimilation schemes is very dependent on the "front-end" processing of the basic observational data. It was therefore decided to hold a meeting which would provide a forum for discussing aspects of observation processing and analysis which receive little attention in formal literature. The resulting workshop, jointly organised by the Operations and Research Departments, covered two main topics:

- a) availability and quality of meteorological observations:
- b) quality control and selection algorithms in operational data assimilation.

Following various presentations, two working groups considered these topics and formulated many recommendations; some of them are outlined below.

Availability

All conventional data available at 3 hourly intervals should be exchanged globally, and SATOBS should be made available at 6 hourly intervals. The number of mean thickness temperatures in SATEM reports should be reduced so that an increased horizontal coverage is possible without increasing the total volume of SATEM information.

Data quality

Data quality needs to be assessed by comparing observations with analysis and/or first guess fields; also the collocation technique should be used to compare different observation types. It would be beneficial if information about instrument error characteristics could be exchanged on a regular basis.

Monitoring

The annual monitoring carried out by WMO should be enhanced by including information about the timeliness, completeness and coverage of observations. However, data monitoring should also be carried out at major meteorological centres, the results being exchanged with WMO and other centres in a standard format. Overall, there needs to be a greater exchange of data monitoring information between the users and providers of the observations.

Quality control algorithms

Theoretical and practical means are now available for putting quality control algorithms on a sound statistical basis. The implementation of these techniques will give a probability rather than a right/wrong result when the data is quality controlled; this will be of particular benefit when there is only partial information redundancy.

Data selection

In many circumstances the data selection algorithm determines the final structure of the analysis more than the optimum interpolation formulation itself. Therefore, more experiments need to be carried out to assess the ability of the algorithms to remove data redundancy.

The papers presented at the workshop, and reports of the discussions and recommendations of the working groups will be published by the Centre in due course.

- Bob Riddaway, Horst Böttger

* * * * *

THE ECMWF CRAY X-MP/48

The Centre's Four Year Programme of Activities, presented to the Council at its 20th session in November 1984, noted that computing resources available on the present CRAY X-MP/22 system will fall short of the demand from 1986 onwards. The Centre undertook to investigate possible means of meeting the additional requirements, which resulted in a proposal to replace the present CRAY X-MP/22 with a CRAY X-MP/48 in early 1986. This proposal was endorsed by the Technical Advisory Committee at its 9th session (29 April 1985) and approved by the Council at its 21st session (8-9 May 1985). The contract for the replacement of the CRAY X-MP/22 with a CRAY X-MP/48 was accordingly signed on 10 May 1985, and installation of the new system is planned for November 1985.

The CRAY X-MP/48 was announced in 1984. The first system went into Cray's benchmark laboratories in July 1984, and customer shipments started in the beginning of 1985. The CRAY X-MP/48 is the most powerful machine currently marketed by any computer manufacturer, and fully compatible with earlier CRAY X-MP systems. The only machine available at present which is potentially more powerful is the CRAY 2; this machine, however, is rather more experimental, produced in preparation for future CRAY systems. It runs only the UNIX operating system and is not compatible with CRAY X-MP systems.

Some technical details of the hardware

Figure 1 shows how the new CRAY X-MP configuration at the Centre will be. The differences between the current and the new system are as follows:

- the number of CPUs is increased from 2 to 4. The new CPUs have the same characteristics as the old ones, in particular all the timings are the same, and multitasking is done in exactly the same way as on the current system, with the addition that the user can now decide whether to use 1, 2, 3 or 4 CPUs for a particular job, depending upon the requirements of that job.
- The new CPUs have been enhanced to perform scatter/gather and compressed index functions in hardware. This can increase the efficiency of certain kinds of algorithms by up to 70%.
- The central memory has been expanded from 2 million words to 8 million words. This will significantly increase the efficiency of the system by allowing more jobs to be active at the same time, and by simplifying coding of the model and other major applications.
- The number of memory banks has been increased from 16 to 64. This will increase the efficiency of the individual CPU by around 8%.
- The SSD has been expanded to 32 million words, thus allowing, for instance, efficient running of two copies of the T106 model at the same time. The transfer rate between SSD and main memory has been increased to around 1000 million bytes per second.

The buffer memory of the IOS has been expanded from 1 million words to 4 million words. This enhanced IOS has the potential to support the newly announced DD49 disk units which offer higher capacity and higher performance.

Fig. 1: Configuration of the CRAY X-MP/48 system

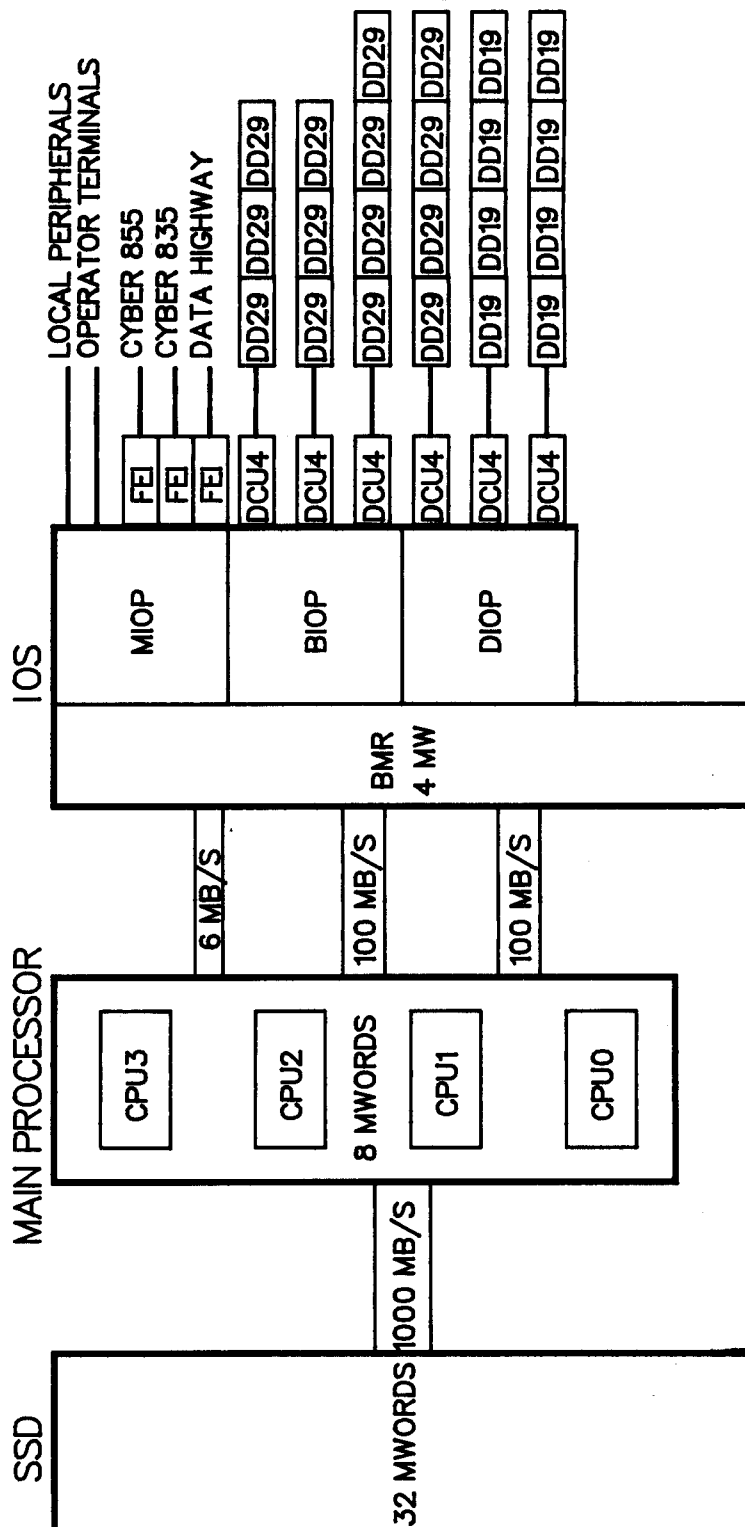

Benchmarking a CRAY X-MP/48

In February of this year the Centre ran benchmarks on a CRAY X-MP/48 system similar to the one which we will receive later this year. The main differences in hardware were that the SSD available was 128 Megawords in size connected via 2 channels, and the disks used were DD-49 drives which are approximately 2.5 times faster than the DD-29 models currently used at the Centre.

The benchmark consisted of 2 types of test. The first comprised runs of ECMWF's high-resolution spectral model T106. The second comprised runs of various other programs including a grid-point model, T63 and T21 spectral models and special kernels to test various features of the hardware. Over 20 different tests were run, some using SSD, some using disk, some multitasking, some single-tasking, some stand alone, some multi-programming.

Of all the tests run, those involving the high resolution T106 model provided the most interesting results. These are summarised below by comparing them with the same tests run on ECMWF's current X-MP/22.

For comparison purposes all test timings were extrapolated to give the time which would be taken by a 10-day forecast.

Results

The first test consisted of running a single-tasked T106 with workfiles on SSD.

Time	X-MP/22	X-MP/48	Ratio
Elapsed (h:m:s)	8:58:40	8:23:40	1.07
CPU (h:m:s)	8:18:03	8:07:43	1.02.

As can be seen, the times are almost identical.

The second test consisted of running a multi-tasked T106 model with workfiles on SSD and with history files also being created on SSD, post-processing was also in effect. On the X-MP/22 we do not have enough space on SSD to accommodate the history files, nor is there enough central memory available to have post-processing without rolling out the model.

Time	X-MP/22	X-MP/48	Ratio
Elapsed (h:m:s)	5:59:10	4:19:30	1.38
CPU (h:m:s)	9:05:49	8:22:53	1.09

As this shows, a reduction in elapsed time of 1 hour 40 mins has already been gained. This gain comes from various sources and can be broken down thus:

- 60 mins (16.2%) - more central memory so that jobs do not have to be rolled in and out;
- 20 mins (5.6%) - more memory banks, the X-MP/22 does not have enough banks to fully support 2 processors;
- 15 mins (4.2%) - more SSD space available for history files;
- 5 mins (1.4%) - faster SSD channel.

The third test consisted of running 2 copies of a multitasked T106 with workfiles on SSD. Both copies run simultaneously on the X-MP/48 but have to be run consecutively on the X-MP/22.

Time	X-MP/22	X-MP/48	Ratio
Elapsed (h:m:s)	11:58:20	5:07:20	2.34
CPU (h:m:s)	18:11:38	17:14:40	1.06

Here a reduction in elapsed time of 6 hrs 51 mins has been gained.

The last test consisted of running 4 copies of a single-tasked T106 with workfiles on SSD. Again, these ran simultaneously on the X-MP/48 but consecutively on the X-MP/22. It must also be added that the X-MP/48 jobs needed 64 Megawords of SSD.

Time	X-MP/22	X-MP/48	Ratio
Elapsed (h:m:s)	35:55:40	8:46:40	3.83
CPU (h:m:s)	33:12:12	33:40:28	0.99

Here a staggering reduction in elapsed time of nearly 25 hours has been gained.

Conclusion

Besides proving that the X-MP/48 is fully upwards compatible with the X-MP/22, it has been shown by these benchmarks that the performance which can be obtained from this machine varies according to the workload. However, in general, it is not unreasonable to expect a performance of between 2 and 2.3 that of our current X-MP/22.

- Neil Storer

* * * * *

STILL VALID NEWS SHEETS

Below is a list of News Sheets that still contain some valid information which has not been incorporated into the Bulletin set (up to News Sheet 175). All other News Sheets are redundant and can be thrown away. The following News Sheets can be discarded since this list was last published: 173.

<u>No.</u>	<u>Still Valid Article</u>
16	Checkpointing and program termination
19	CRAY UPDATE (temporary datasets used)
56	DISP
67	Attention Cyber BUFFER IN users
73	Minimum Cyber field length
89	Minimum field length for Cray jobs
93	Stranger tapes
118	Terminal timeout
120	Non-permanent ACQUIRE to the Cray
121	Cyber job class structure
122	Mixing FTN4 and FTN5 compiled routines
127	(25.1.82) IMSL Library
130	Contouring package: addition of highs and lows
135	Local print file size limitations
136	Care of terminals in offices
140	PURGE policy change
141	AUTOLOGOUT - time limit increases
144	DISSPLA FTN5 version
152	Job information card
158	Change of behaviour of EDIT features SAVE, SAVEX. Reduction in maximum print size for AB and AC
164	CFT New Calling Sequence on the Cray X-MP
165	Maximum memory size for Cray jobs
166	Corrections to the Contouring Package
167	CFT 1.13 improvements
170	NOS/BE level 604
171	" " "
172	" " "
	Change to CFT Compiler default parameter (ON=A)
174	Warning against mixing FTN4 and FTN5 compiled routines.

* * * * *

REMOVING MAGNETIC TAPES FROM THE CENTRE'S TAPE LIBRARY

In future, whenever a user requests removal of a magnetic tape belonging to the Centre from the tape library, they will be required to complete and sign a "Receipt of Magnetic Tape" form. In particular, if the tape is not returned to the Library within 2 months, a fee of 25 pounds sterling becomes payable.

For requests from outside the Centre, the form will be dispatched with the tape(s), and the user requested to complete and return the form on receipt of the tape(s).

- Eric Walton

* * * * *

1985 ECMWF SEMINAR
PHYSICAL PARAMETERIZATION FOR
NUMERICAL MODELS OF THE
ATMOSPHERE
9-13 SEPTEMBER 1985

PROPOSED PROGRAMME

- R.A. ANTHES** *Introduction to parameterization of physical processes in numerical models*
Parameterization of moist convective effects on the thermodynamic and moisture field in numerical models.
Validation of parameterization schemes for moist convection
- M.J. MILLER** *A new convective adjustment scheme and its impact on the ECMWF model*
- M.W. MONCRIEFF** *Convective momentum transport*
- J.C. ANDRE** *Multi-level boundary layer schemes*
Validation of boundary layer schemes
- A.G.M. DRIEDONKS** *Bulk boundary layer schemes*
- D.A. RANDALL** *Interactions between the PBL and convection*
- Y. MINTZ** *Impact of surface processes on forecasts*
- P. SELLERS** *Schemes for parameterizing surface processes*
- A.J. THORPE** *Parameterization of mesoscale processes*
- H. SUNDQVIST** *Parameterization of stratiform condensation*
- G. STEPHENS** *Radiation schemes*
Effects of clouds on radiation
- Y. FOUQUART** *Intercomparison and impact of radiation schemes*
- J. SLINGO** *Parameterization of cloud cover*
- P.J. MASON** *On the parameterization of orographic drag*
- M. JARRAUD** *Impact of an 'envelope' orography in the ECMWF model*
- G.J. SHUTTS** *Parameterization of sub-grid scale gravity wave momentum transfer and its influence in forecast/climate models*
- A. DICKINSON** *The impact of some physical parameterizations on the UK Meteorological Office's forecast models*
- M. TIEDTKE** *Effect of physical processes in the large-scale flow in the ECMWF model*

For further information contact: Dr. Bob Riddaway, ECMWF,

ECMWF PUBLICATIONS

- TECHNICAL MEMORANDUM NO. 96: General circulation and diagnostic statistics
- TECHNICAL MEMORANDUM NO. 97: Numerical Prediction: Some results from operational forecasting at ECMWF
- TECHNICAL MEMORANDUM NO. 98: Estimates of round-off error in the inversion of positive definite matrices
- SEMINAR/WORKSHOP 1984: Data Assimilation System experiments with particular emphasis on FGGE
- DAILY GLOBAL ANALYSIS: April - June 1984
- FORECAST AND VERIFICATION CHARTS: up to 28 February 1985

* * * * *

CALENDAR OF EVENTS AT ECMWF

- 9-13 September 1985 Annual ECMWF seminar: "Physical Parameterisation for numerical models of the atmosphere"
- 16-18 September 1985 14th session of Scientific Advisory Committee
- 18-20 September 1985 10th session of Technical Advisory Committee
- 20-21 November 1985 22nd session of Council
- 22 November 1985 ECMWF 10th anniversary celebration

* * * * *

THE CENTRE'S 10TH ANNIVERSARY CELEBRATIONS

This year, the Centre will celebrate ten years of fruitful European co-operation and achievement in medium-range weather forecasting. On 1 November 1975 the Convention establishing ECMWF entered into force, having been ratified by 13 Member States; the Centre then became an intergovernmental organisation.

It is planned to have a celebration of the Centre's 10th Anniversary on Friday, 22 November 1985. During the day, there will be a special scientific seminar at the Centre, followed by a celebration dinner dance at a nearby venue. The event will be attended by ECMWF Council members, Centre staff and invited guests.

* * * * *

INDEX OF STILL VALID NEWSLETTER ARTICLES

This is an index of the major articles published in the ECMWF Newsletter plus those in the original ECMWF Technical Newsletter series. As one goes back in time, some points in these articles may have been superseded. When in doubt, contact the author or User Support.

	<u>No.*</u>	<u>Newsletter</u> <u>Date</u>	<u>Page</u>
<u>CRAY</u>			
Bi-directional memory	25	Mar. 84	11
Buffer sizes for jobs doing much sequential I/O	14	Apr. 82	12
CFT 1.11 Subroutine/function calling sequence change	19	Feb. 83	13
COS 1.12 and products	23	Oct. 83	17
Cray X-MP - description of	21	June 83	16
- hints on using it	26	June 84	10
Dataset storage	13	Feb. 82	11
Multifile tapes - disposing of	17	Oct. 82	12
Multitasking ECMWF spectral model	29	Mar. 85	21
Public Libraries	T5	Oct. 79	6
<u>CYBER</u>			
Arithmetic instructions - comparative speeds of execution on the Cyber front ends	14	Apr. 82	17
Cyber front ends - execution time differences	15	June 82	9
Buffering or non-buffering on Cyber?	15	June 82	10
CMM-Fortran interface	10	Aug. 81	11
Cyber 855 - description of	21	June 83	18
Dynamic file buffers for standard formatted/unformatted data	3	June 80	17
Formatted I/O - some efficiency hints	4	Aug. 80	9
FTN4 to FTN5 conversion	6	Dec. 80	15
FTN5 - effective programming	9	June 81	13
& - optimisation techniques	10	Aug. 81	13
& - optimisation techniques	14	Apr. 82	13
& - optimisation techniques	15	June 82	10
Graphics - hints on memory and time saving	T6	Dec. 79	20
- a summary of planned services	17	Oct. 82	10
Magnetic tapes - hints on use	T2	Apr. 79	17
- making back-up copies	1	Feb. 80	9
Public libraries	T5	Oct. 79	6

<u>GENERAL</u>	<u>No.*</u>	<u>Newsletter</u>	
		<u>Date</u>	<u>Page</u>
COMFILE	11	Sept.81	14
Data handling sub-system	22	Aug. 83	17
ECMWF publications - range of	26	June 84	16
Member State Technical and Computing Representatives and Meteorological Contact Points	25	Mar. 84	18
Output files - controlling destination of, in Cray and Cyber jobs	14	Apr. 82	20
Resource allocation in 1984	24	Dec. 83	20
Resource distribution rules	18	Dec. 82	20
"Systems" booking times	27	Sept.84	
Telecommunications schedule	24	Dec. 83	22
Upper and lower case text files	11	Sept.81	15
 <u>METEOROLOGY</u>			
ALPEX: the alpine experiment of the GARP mountain sub-programme	14	Apr. 82	2
Alpex data management and the international Alpex data centre	11	Sept.81	1
Cloud Cover Scheme	29	Mar. 85	14
Diurnal radiation cycle - introduction of	26	June 84	1
ECMWF Analysis and Data Assimilation System	T3	June 79	2
ECMWF Limited Area Model	16	Aug. 82	6
ECMWF Operational Schedule, Data and Dissemination	12	Dec. 81	1
ECMWF Production Schedule	6	Dec. 80	5
Facilities to verify and diagnose forecasts provided by the Data & Diagnostics Section	8	Apr. 81	3
Forecast products of various centres decoded and plotted at ECMWF	9	June 81	3
Forecast model - T106 high resolution	29	Mar. 85	3
GTS: ECMWF grid code product distribution	27	Sept.84	6
Operational Archive Access facilities	16	Aug. 82	14
Operational Forecast Suite (EMOS)			
- general description	T1	Feb. 79	6
- data acquisition and decoding	T6	Dec. 79	1
- initialisation	T6	Dec. 79	4
- quality control	1	Feb. 80	3
- bulletin corrections (CORBUL)	2	Apr. 80	1
- archiving	3	June 80	4
- post processing	4	Aug. 80	3
- significant change made	12	Dec. 81	3
Pseudo "satellite picture" presentation of model results	1	Feb. 80	2
Spectral model	7	Feb. 81	4
- development of	15	June 82	1
- as new operational model	20	Apr. 83	1
- Gaussian grid and land-sea mask used	21	June 83	8

*T indicates the original Technical Newsletter series

USEFUL NAMES AND 'PHONE NUMBERS WITHIN ECMWF

		<u>Room*</u>	<u>Ext.**</u>
Director	- Lennart Bengtsson	OB 202	200
Head of Operations Department	- Daniel Söderman	OB 010A	373
ADVISORY OFFICE - Open 9-12, 14-17 daily		CB Hall	309
Other methods of quick contact:			
- telex (No. 847908)			
- COMFILE (See Bulletin B1.5/1)			
Computer Division Head	- Geerd Hoffmann	OB 009A	340/342
Communications & Graphics Section Head	- Peter Gray	OB 101	369
COMPUTER OPERATIONS			
Console	- Shift Leaders	CB Hall	334
Reception Counter)	- Jane Robinson	CB Hall	332
Tape Requests)			
Terminal Queries	- Norman Wiggins	CB 035	209
Operations Section Head	- Eric Walton	CB 023	351
Deputy Ops. Section Head	- Graham Holt	CB 024	306
DOCUMENTATION	- Pam Prior	OB 016	355
Distribution	- Els Kooij- Connally	Library	430
Libraries (ECMWF, NAG, CERN, etc.)	- John Greenaway	OB 017	354
METEOROLOGICAL DIVISION			
Division Head	- Frédéric Delsol	OB 008	343
Applications Section Head	- Rex Gibson	OB 227	448
Operations Section Head (Acting)	- Horst Böttger	OB 004	347
Meteorological Analysts	- Veli Akyildiz	OB 005	346
	- Herbert Pümpel	OB 006	345
	- Liam Campbell	OB 003	348
Meteorological Operations Room	-	CB Hall	328/443
REGISTRATION			
Project Identifiers	- Pam Prior	OB 016	355
Intercom & Section Identifiers	- Jane Robinson	CB Hall	332
Operating Systems Section Head	- Claus Hilberg	CB 133	323
Telecommunications Fault Reporting	- Stuart Andell	CB 035	209
User Support Section Head	- Andrew Lea	OB 018	353
RESEARCH DEPARTMENT			
Head of Research Department	- David Burridge	OB 119A	399
Computer Coordinator	- David Dent	OB 123	387
Meteorological Education and Training	- Bob Riddaway	OB 319	478

* CB - Computer Block
OB - Office Block

** The ECMWF telephone number is READING (0734) 876000
international +44 734 876000