

# AccuRT: a versatile tool for radiative transfer simulations in a coupled atmosphere-water system

## The AccuRT\* Development Team:

B. Hamre<sup>a</sup>, J. J. Stamnes<sup>a</sup>,  
S. Stamnes<sup>b</sup>, N. Chen<sup>b</sup>, Y. Fan<sup>b</sup>, W. Li<sup>b</sup>, Z. Lin<sup>b</sup>, and K. Stamnes<sup>b</sup>

<sup>a</sup>Department of Physics and Technology  
University of Bergen, Bergen, Norway

<sup>b</sup>Light and Life Laboratory  
Department of Physics  
Stevens Institute of Technology  
Hoboken, New Jersey, USA

---

\*Stamnes, K., B. Hamre, S. Stamnes, N. Chen, Y. Fan, W. Li, Z. Lin, and J. J. Stamnes, Progress in forward-inverse modeling based on radiative transfer tools for coupled atmosphere-snow/ice-ocean systems: A review and description of the AccuRT model, Applied Sciences, 8, 2682, 2018.



# Outline

- **Background/Motivation**
- **Brief Review of Current Status – Future Needs?**
- **Unified Treatment of Atmosphere and Water:<sup>†</sup>**
  - **DIScrete Ordinate Radiative Transfer (DISORT) for a Coupled Atmosphere-Water System**
- **Overview of AccuRT/Key Features:**
  - **A Robust, User-friendly, and Reliable Tool for Radiative Transfer Simulations throughout an Atmosphere Overlying a Water Body**
- **Results**
  - **Comparison with Benchmarks**
  - **Radiance Simulations**
- **Summary**
- **Examples of Use**

---

<sup>†</sup>The word “water” is used here to mean either liquid water or snow/ice.



# Background/Motivation

Good radiative transfer (RT) simulation tools are important because, for user-specified inherent optical properties (IOPs), they:

- can be used to generate
  1. **irradiances** at any user-specified levels in an atmosphere-water system as well as
  2. **radiances** [ $I(\tau, \mu, \phi)$ , see Eq. (1) below] at any user-specified levels and directions;
- will avoid unnecessary loss of time spent on developing tools that in general will be:
  - less reliable, less general, and
  - more likely to produce erroneous results
- will lead to significant progress in research areas such as:
  - **remote sensing algorithm development**
  - **climate research**
  - **other atmospheric and hydrologic applications.**



# Brief Review of Current Status – Future Needs?

Typical tools currently available:

- SBDART, Streamer, LibRadtran – **atmosphere only**
  - good tools for atmospheric applications
  - no coupling to underlying water body – oceanic input is a boundary condition
- Hydrolight – **ocean (natural waters) only**
  - good tool for marine optics applications – provides water-leaving radiance, but no TOA radiance
  - no coupling to atmosphere – atmospheric input is a boundary condition

Very few reliable, well-tested, and user-friendly RT tools for a **coupled** atmosphere-water system are available. Therefore, the **AccuRT** tool described here:

- **will fill an existing need.**

**AccuRT** is well-tested and was designed to be:

- **reliable, robust, versatile, and easy-to-use.**



# Schematic Illustration of Atmosphere – Water System

## The coupled atmosphere ocean system

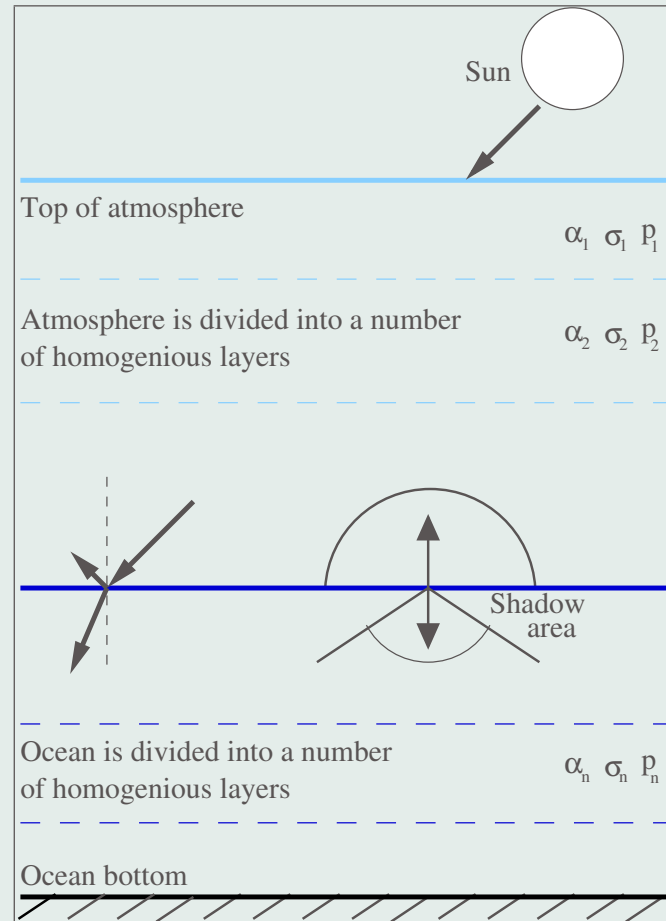

Note:  $\sigma \rightarrow \beta$  in the following!

# Unified Treatment of Atmosphere and Water

In either of the two slabs (atmosphere or water), the diffuse radiance distribution  $I(\tau, \mu, \phi)$  can be described by the radiative transfer equation (RTE):

$$\begin{aligned} \mu \frac{dI(\tau, \mu, \phi)}{d\tau} &= I(\tau, \mu, \phi) - S^*(\tau, \mu', \phi') - [1 - \varpi(\tau)]B(T(\tau)) \\ &\quad - \frac{\varpi(\tau)}{4\pi} \int_0^{2\pi} d\phi' \int_{-1}^1 p(\tau, \mu', \phi'; \mu, \phi) I(\tau, \mu', \phi') d\mu'. \end{aligned} \quad (1)$$

Here  $\mu$  is the cosine of the polar angle  $\theta$ , and  $\phi$  is the azimuth angle. **The inherent optical properties (IOPs) are: the absorption coefficient,  $\alpha(\tau)$ , the scattering coefficient,  $\beta(\tau)$ , and the scattering phase function,  $p(\tau, \mu', \phi'; \mu, \phi)$ .** The ratio  $\varpi(\tau) = \beta(\tau)/[\alpha(\tau) + \beta(\tau)]$  is called the single-scattering albedo,  $S^*(\tau, \mu', \phi') \propto \varpi F_0$ , where  $F_0$  is the incident solar irradiance, and  $B(T(\tau))$  is the Planck function. The differential vertical optical depth is

$$d\tau(z) = -[\alpha(\tau) + \beta(\tau)]dz \quad (2)$$

where the minus sign indicates that  $\tau$  increases in the downward direction, whereas  $z$  increases in the upward direction. The scattering angle  $\Theta$  and the polar and azimuth angles are related by

$$\cos \Theta = \cos \theta \cos \theta' + \sin \theta' \sin \theta \cos(\phi' - \phi).$$



# Overview of AccuRT/Key Features

**AccuRT** works as follows:

1. Slab<sub>1</sub> (atmosphere) and slab<sub>2</sub> (water) are separated by a plane interface at which the **refractive index changes from  $m_1$  in slab<sub>1</sub> to  $m_2$  in slab<sub>2</sub>**.
2. Each of the two slabs is divided into a sufficiently large number of homogenous horizontal layers to adequately **resolve the vertical variation** in its IOPs.
3. **Fresnel's equations** for the reflectance and transmittance are **applied at the slab<sub>1</sub>-slab<sub>2</sub> (air-water) interface**, in addition to the **law of reflection and Snell's Law** to determine the directions of the reflected and refracted rays.
4. Discrete-ordinate (DISORT<sup>‡</sup>) solutions to the RTE are computed separately for each layer in the two slabs.
5. Finally, **boundary conditions** at the top of the atmosphere and the bottom of the water are applied, in addition to **continuity conditions** at layer interfaces within each of the two slabs.

<sup>‡</sup>K. Stamnes, S. C. Tsay, W. J. Wiscombe, and K. Jayaweera, Numerically stable algorithm for discrete-ordinate-method radiative transfer in multiple scattering and emitting layered media, Applied Optics, 27, 2502-2509, 1988.



# Results – Validation against Monte Carlo

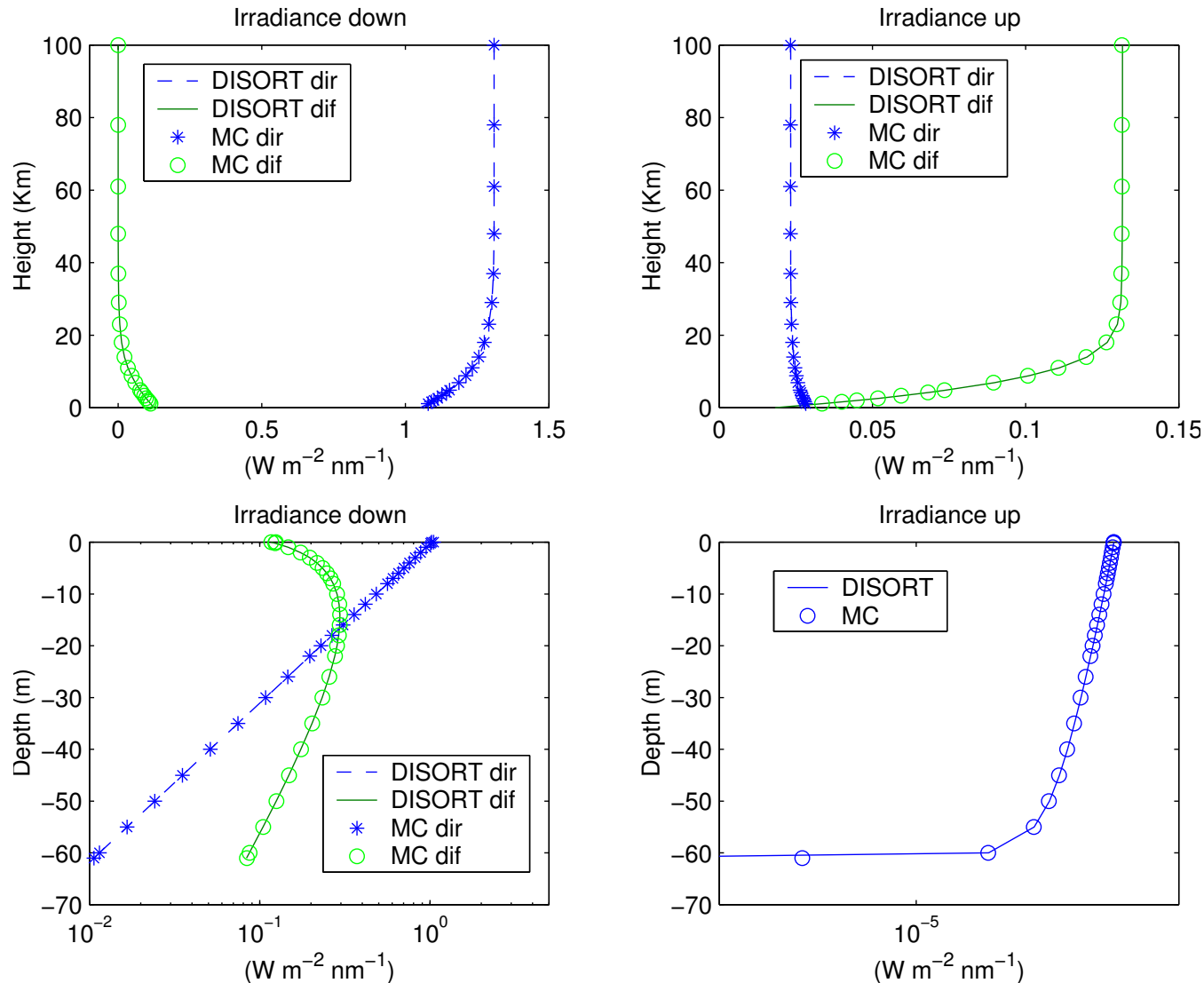

For details, see: K.I. Gjerstad, J.J. Stamnes, B. Hamre, J.K. Lotsberg, B. Yan, and K. Stamnes, Monte Carlo and discrete-ordinate simulations of irradiances in the coupled atmosphere-ocean system, *Appl. Opt.* 42, 2609-2622 (2003).



# Results – Simulated Radiation Field (1)

## Solar spectrum

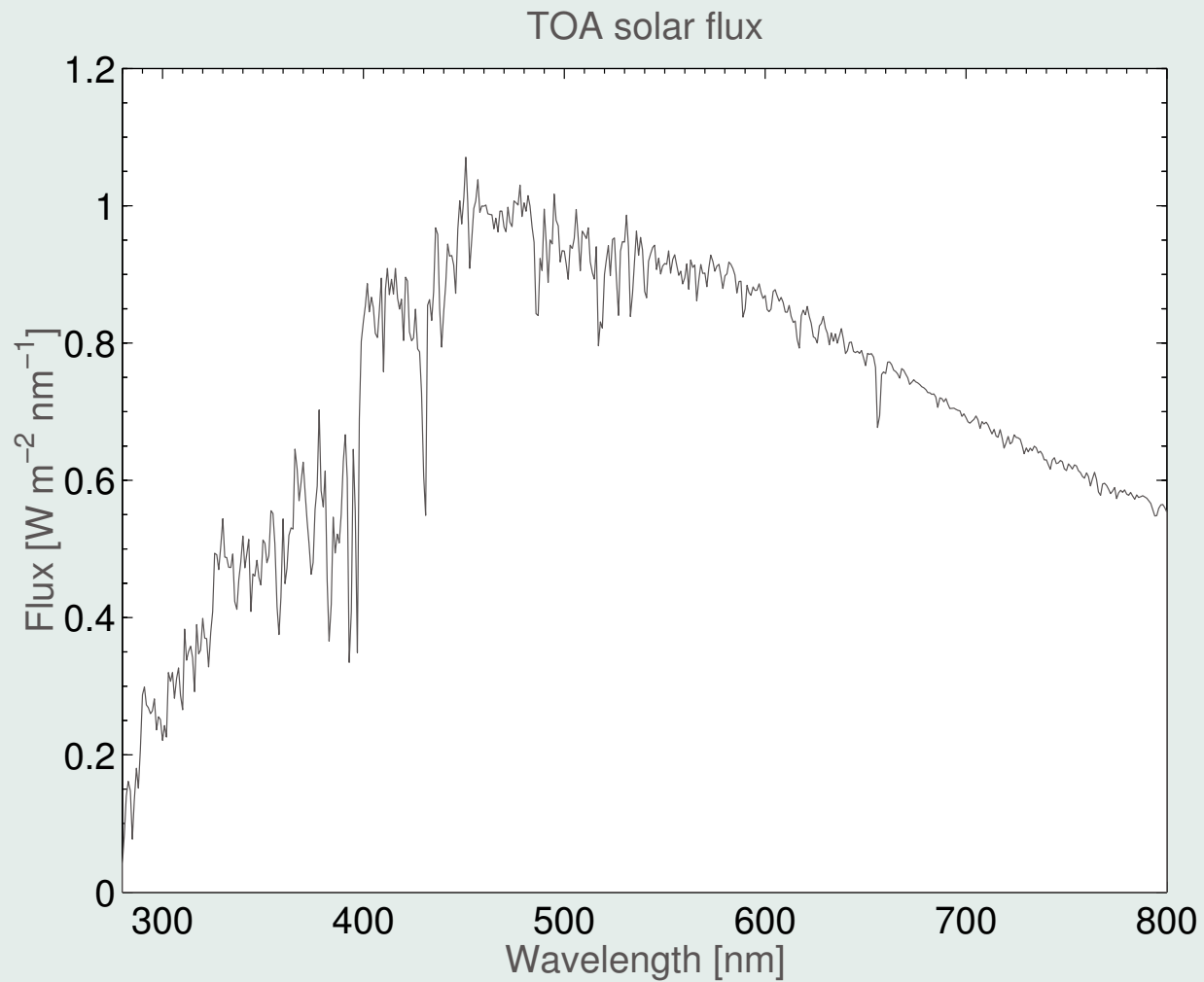

# Results – Simulated Radiation Field (2)

## Color response functions of the eye

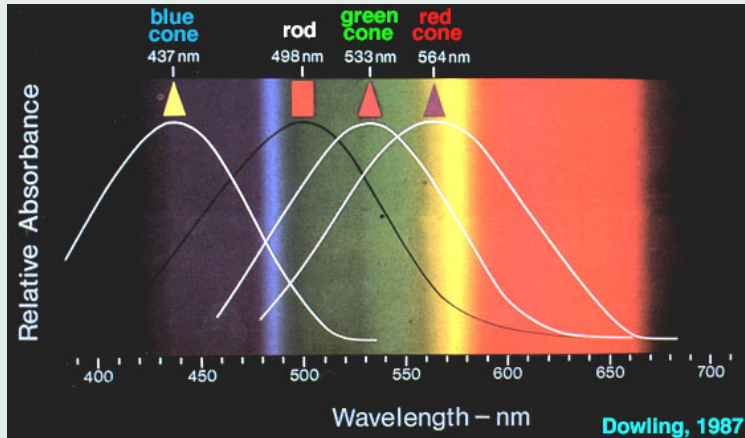

### Tristimulus functions

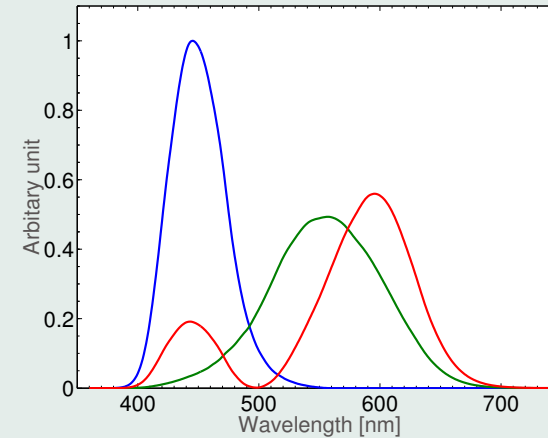

### Tristimulus values

$$X = \int_0^{\infty} F(\lambda) \bar{x}(\lambda) d\lambda$$

$$Y = \int_0^{\infty} F(\lambda) \bar{y}(\lambda) d\lambda$$

$$Z = \int_0^{\infty} F(\lambda) \bar{z}(\lambda) d\lambda$$

### rgb color space

$$\begin{bmatrix} r \\ g \\ b \end{bmatrix} = \left( \begin{bmatrix} \text{A } 3 \times 3 \\ \text{conversion} \\ \text{matrix} \end{bmatrix} \cdot \begin{bmatrix} X \\ Y \\ Z \end{bmatrix} \right)^{\frac{1}{2.2}}$$

## Results – Simulated Radiation Field (3)

### Modeled downward surface solar radiation

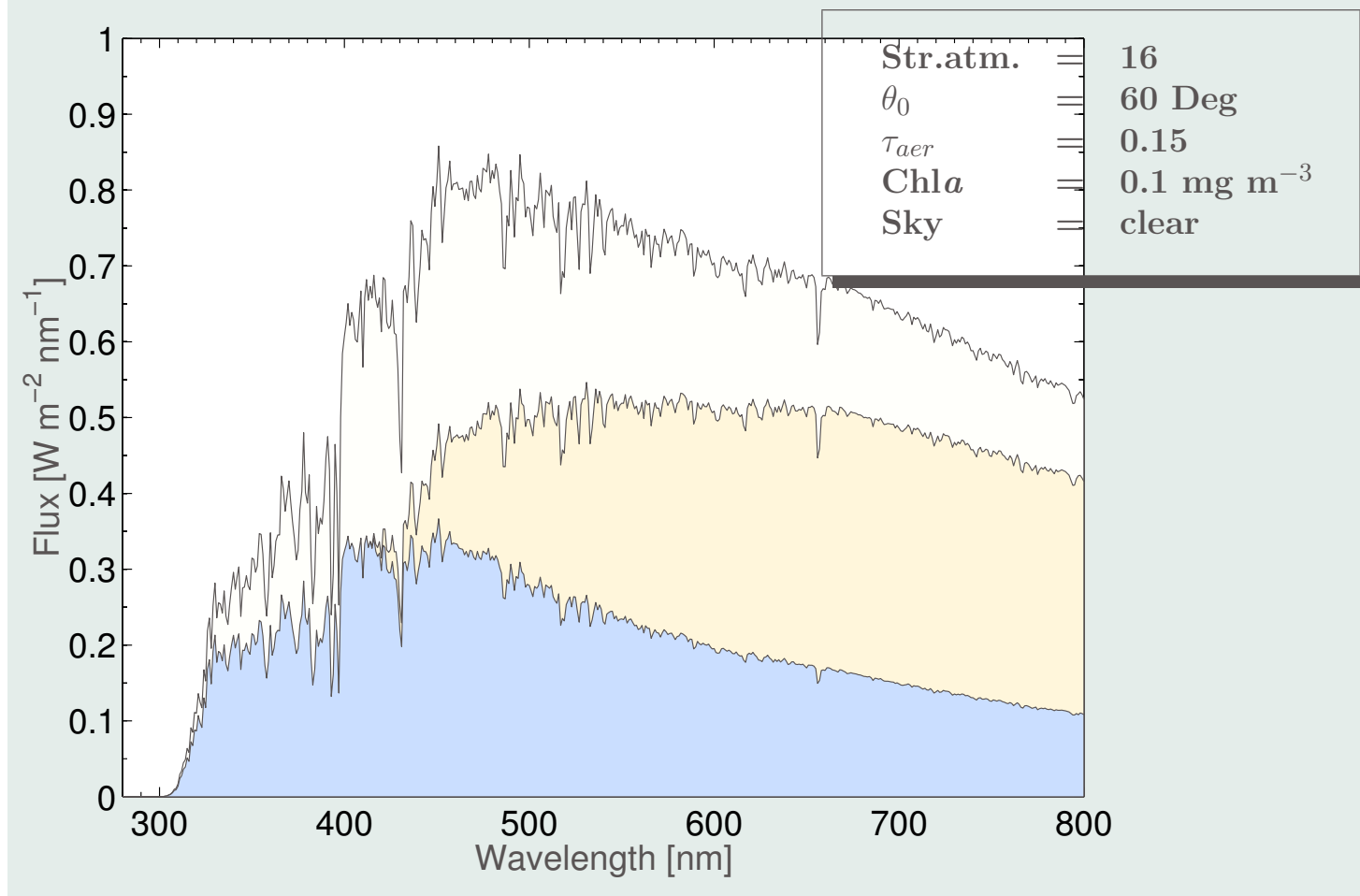

## Results – Simulated Radiation Field (4)

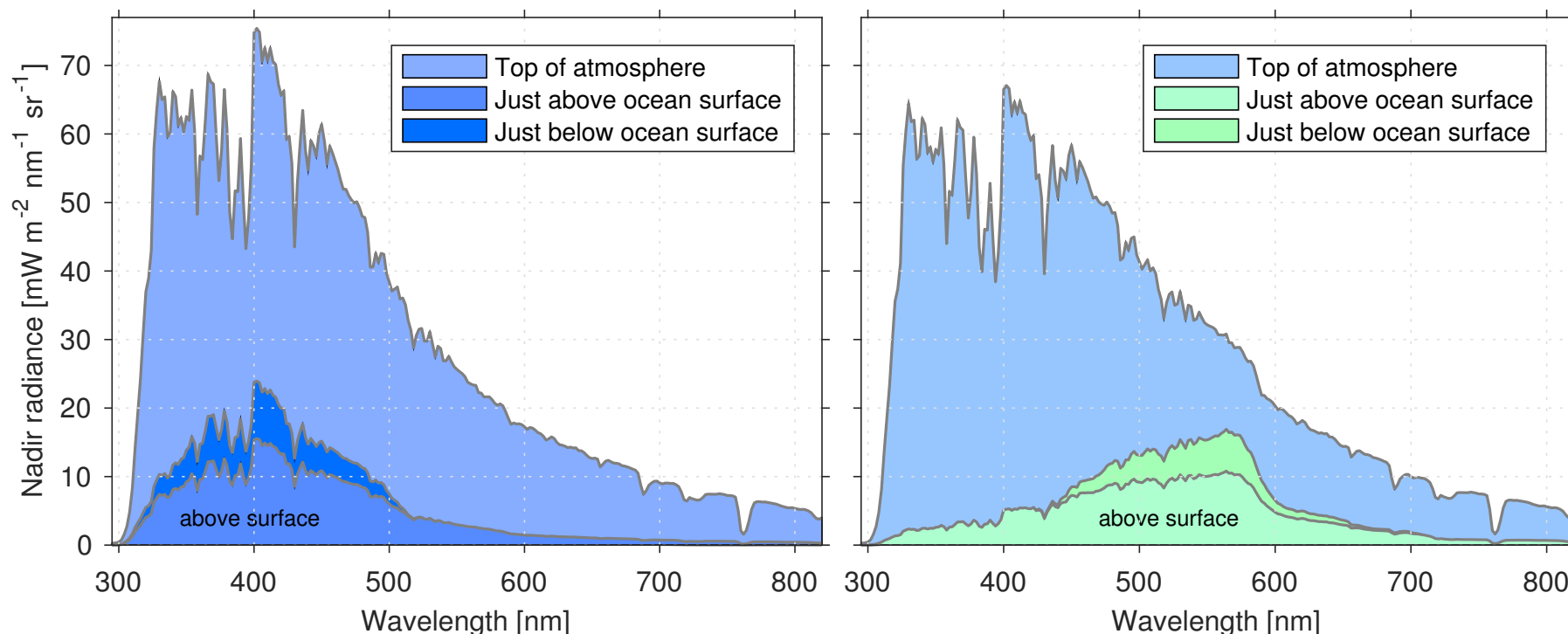

Simulated **upward radiance in the nadir direction** at the top of the atmosphere and close to the ocean surface.

Solar zenith angle =  $45^\circ$ , US Standard atmosphere with aerosol optical depth = 0.23 at 500 nm.

(**Left**) Clear water with chlorophyll concentration =  $0.1 \text{ mg}\cdot\text{m}^{-3}$ , MIN =  $0.003 \text{ g}\cdot\text{m}^{-3}$ , CDOM443 =  $0.003 \text{ m}^{-1}$  (CCRR bio-optical model).

(**Right**) Turbid water with chlorophyll concentration =  $10 \text{ mg}\cdot\text{m}^{-3}$ , MIN =  $0.1 \text{ g}\cdot\text{m}^{-3}$ , CDOM443 =  $0.1 \text{ m}^{-1}$ .



# Results – Simulated Subsurface Radiation Cone (1)

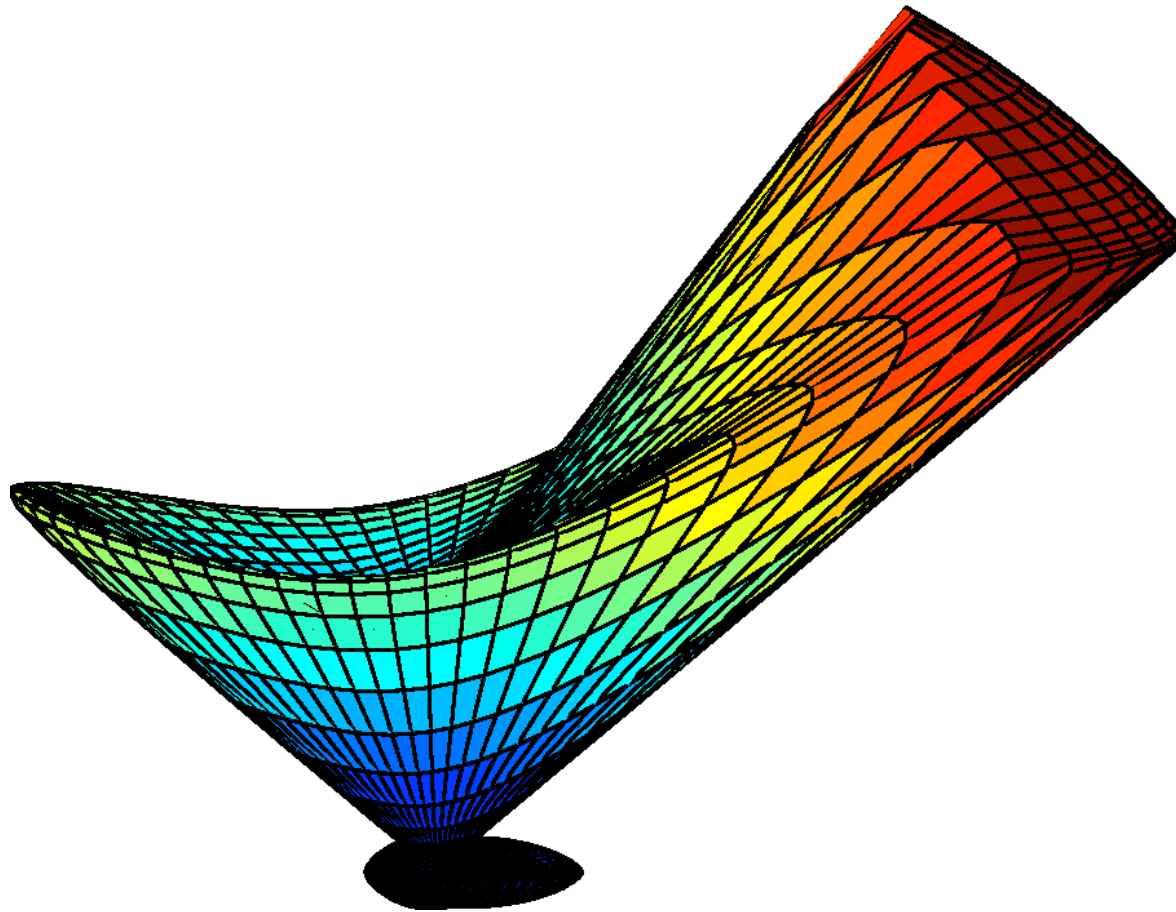

# Results – Simulated Subsurface Radiation Cone (2)

## Subsurface radiation cone

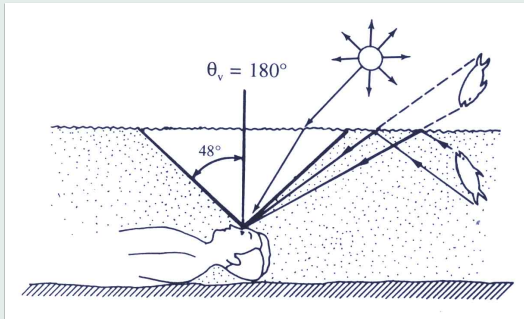

Adapted from Mobley, 1994

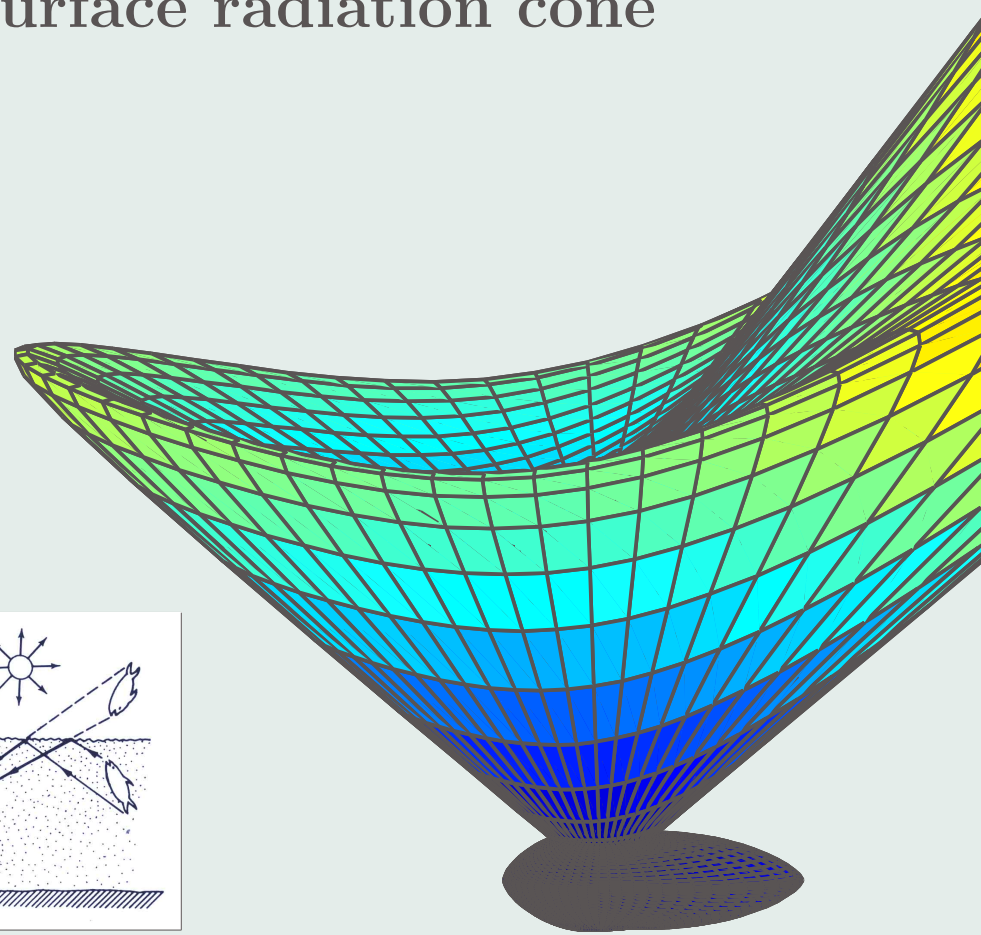

**Light and Life** Laboratory  
STEVENSONS  
Institute of Technology



# Summary (1)

We have provided a brief description of **AccuRT**:

- **a reliable, robust, user-friendly, and versatile tool for radiative transfer simulations in a coupled atmosphere-water system.**

The required input parameters are:

- layer-by-layer optical depths and IOPs consisting of absorption and scattering coefficients as well as the scattering phase function.

**AccuRT** has the following unique features:

1. it allows for a user-specified number of layers in the atmosphere and water to adequately resolve the vertical variation in IOPs;
2. it computes upward and downward irradiances, scalar irradiances, and diffuse attenuation coefficients at user-specified optical depths in the atmosphere and water;
3. it computes radiances in user-specified directions at user-specified optical depths in the atmosphere and water.

A version of AccuRT that deals with **polarized radiation** is also available.



## Summary (2)

The IOPs can be:

- either user-specified or selected from a suite of IOPs based on published models and data, including IOP models for open ocean and turbid coastal waters;
- clear-sky atmosphere IOPs include molecular scattering and gaseous absorption;
- standard models for aerosol/cloud scattering and absorption are included.

**AccuRT** is designed to address the needs of researchers interested in:

- analyzing irradiance and radiance measurements in the field or laboratory
- making simulations of irradiances or radiances in support of
  - remote sensing algorithm development
  - climate research (data assimilation)
  - other atmospheric and hydrologic applications.

In conclusion: **AccuRT** is expected to fill an existing need and be:

- *a valuable and indispensable tool for teachers, students as well as researchers in the atmospheric optics, ocean optics, climate research, and remote sensing communities.*



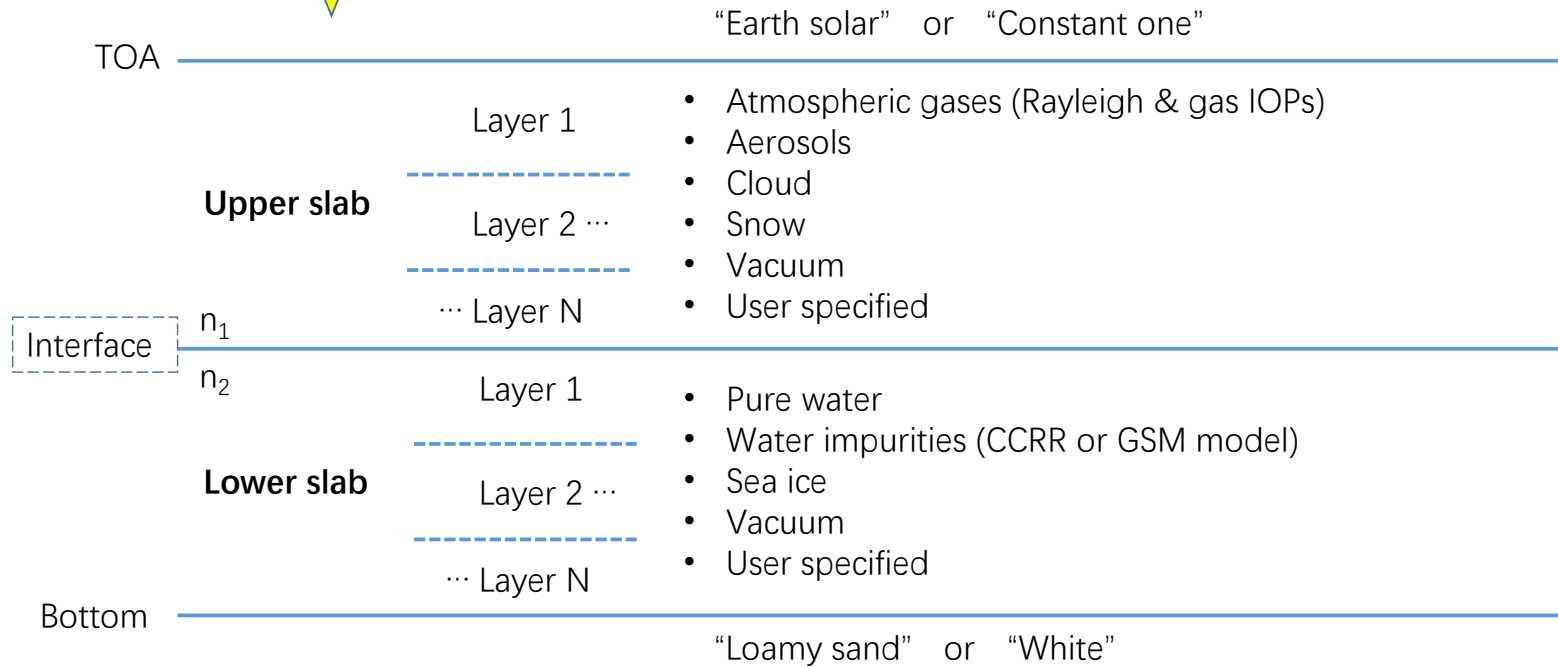

Table 1: Core materials included in AccuRT.

| Core Material                  | options                        | allowed position | descriptions   |
|--------------------------------|--------------------------------|------------------|--|
| <b>earth_atmospheric_gases</b> |                                |                  |  |
|                                | 1. gasIOP<br>2. air            | upper slab       | profiles of atmospheric molecular absorption and Rayleigh scattering optical depths.                         |
| <b>aerosols</b>                |                                |                  | particulate matter in the atmosphere.  |
| <b>clouds</b>                  | 1. water cloud<br>2. ice cloud | upper slab       | clouds consisting of liquid water droplets and ice particles in the atmosphere.                              |
| <b>pure_water</b>              |                                | lower slab       | pure water.  |
| <b>water_impurities_ccrr</b>   |                                | lower slab       | dissolved and particulate matter in the water based on the CCRR bio-optical model.                           |
| <b>water_impurities_gsm</b>    |                                | lower slab       | dissolved and particulate matter in the water based on the GSM bio-optical model.                            |
| <b>vacuum</b>                  |                                | both slabs       | synthetic material which allows for either of the two slabs comprising the coupled medium to be transparent. |
| Cryosphere Material            | options                        | allowed position | descriptions   |
| <b>snow</b>                    | 1. ISIOP<br>2. Mie             | upper slab       | snow material  |
| <b>ice</b>                     | 1. ISIOP<br>2. Mie             | lower slab       | ice floating over ocean  |

# AccuRT Configuration (1)

## Basic structure



## AccuRT Configuration (2)

STR1 = number of streams in upper slab.

### Setup AccuRT

- **Source:** solar spectrum or “constant one” ; scaling factor is 1.0 by default, solar zenith angle is 45 by default.
- **Bottom:** “loamy sand” or if “white” (no wavelength dependence); specify albedo, default is 0.0.
- **Streams:** stream number can be set in the upper slab, stream number in the lower slab is computed as:  
 $STR2 = STR1 * n_2^2$ .
- **Layers:** layers can be set by specifying various depths in the upper or lower slab. Total depth of the upper slab is 100 km.
- **Materials:** materials can be added in desired layers by setting the material profile.  
General format of the material profile is: layer number, amount of materials.
- **Output:** specify output depths, angles, wavelengths, irradiances, radiances, IOPs, etc.



# AccuRT Examples (1)

## AccuRT examples: Coupled atmosphere-ocean system

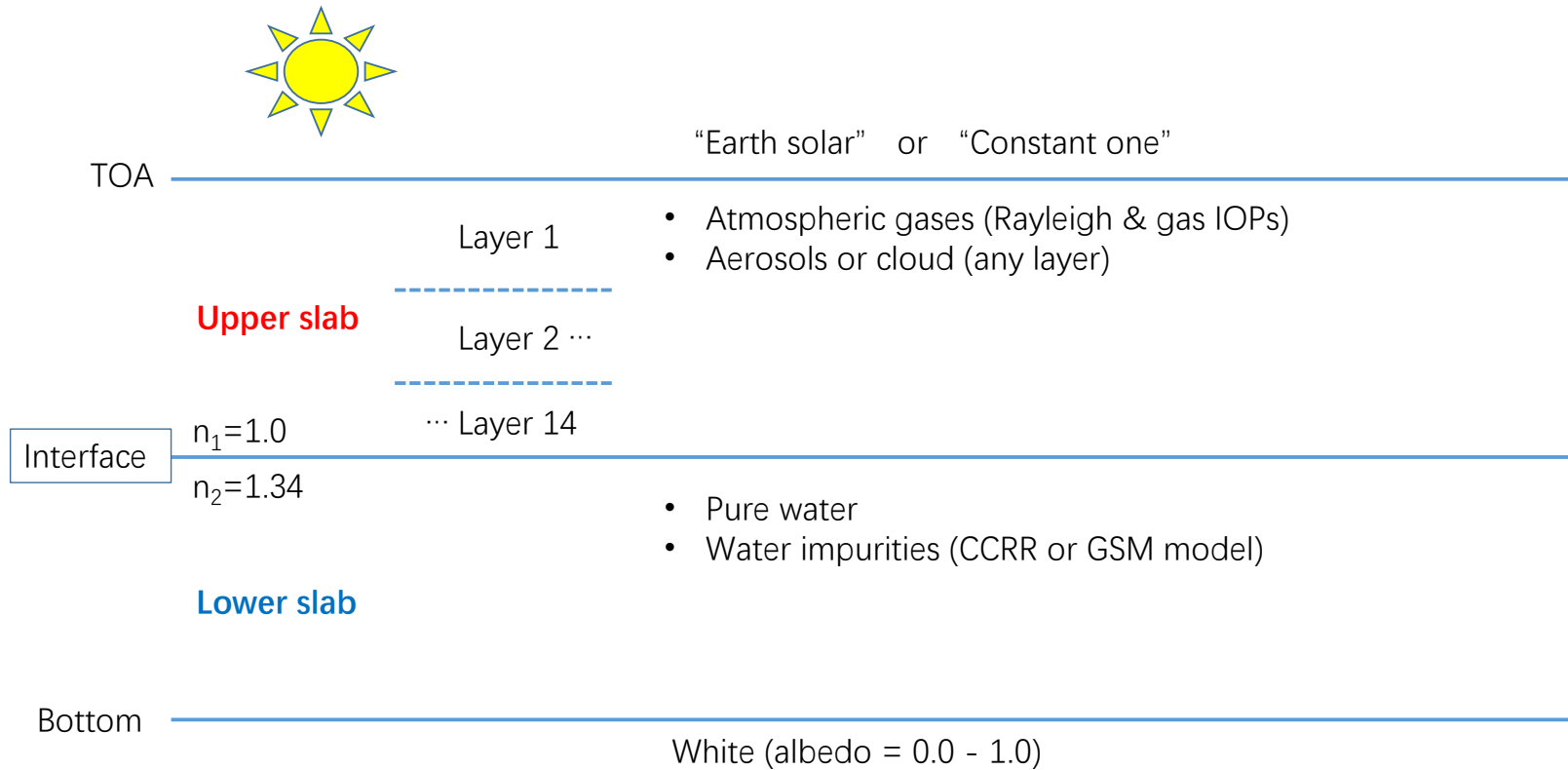

# AccuRT Examples (2)

## AccuRT examples of configuration file: Coupled atmosphere-ocean system



**SOURCE\_TYPE** = earth\_solar or constant one

“Earth solar” or “Constant one”

TOA

**LAYER\_DEPTH\_UPPER\_SLAB**  
= 30.0E3 50.0E3 ... 100.0E3

Upper slab

Layer 1

- Atmospheric gases (Rayleigh & gas IOPs)
- Aerosols or cloud (any layer)

Layer 2 ...

**MATERIALS\_INCLUDED\_UPPER\_SLAB**  
= earth\_atmospheric\_gases aerosols

... Layer 14

Interface

$n_1=1.0$

$n_2=1.34$

- Pure water
- Water impurities (CCRR or GSM model)

Lower slab

**LAYER\_DEPTH\_LOWER\_SLAB**  
= 100

**MATERIALS\_INCLUDED\_LOWER\_SLAB**  
= pure\_water water\_impurity\_ccrr

Bottom

White (albedo = 0.0 - 1.0)

**BOTTOM\_BOUNDARY\_SURFACE**  
= white

**BOTTOM\_BOUNDARY\_SURFACE\_SCALING\_FACTOR**  
= 0.0

See Appendices of User Manual for description of configuration files.



# AccuRT Examples (2b)

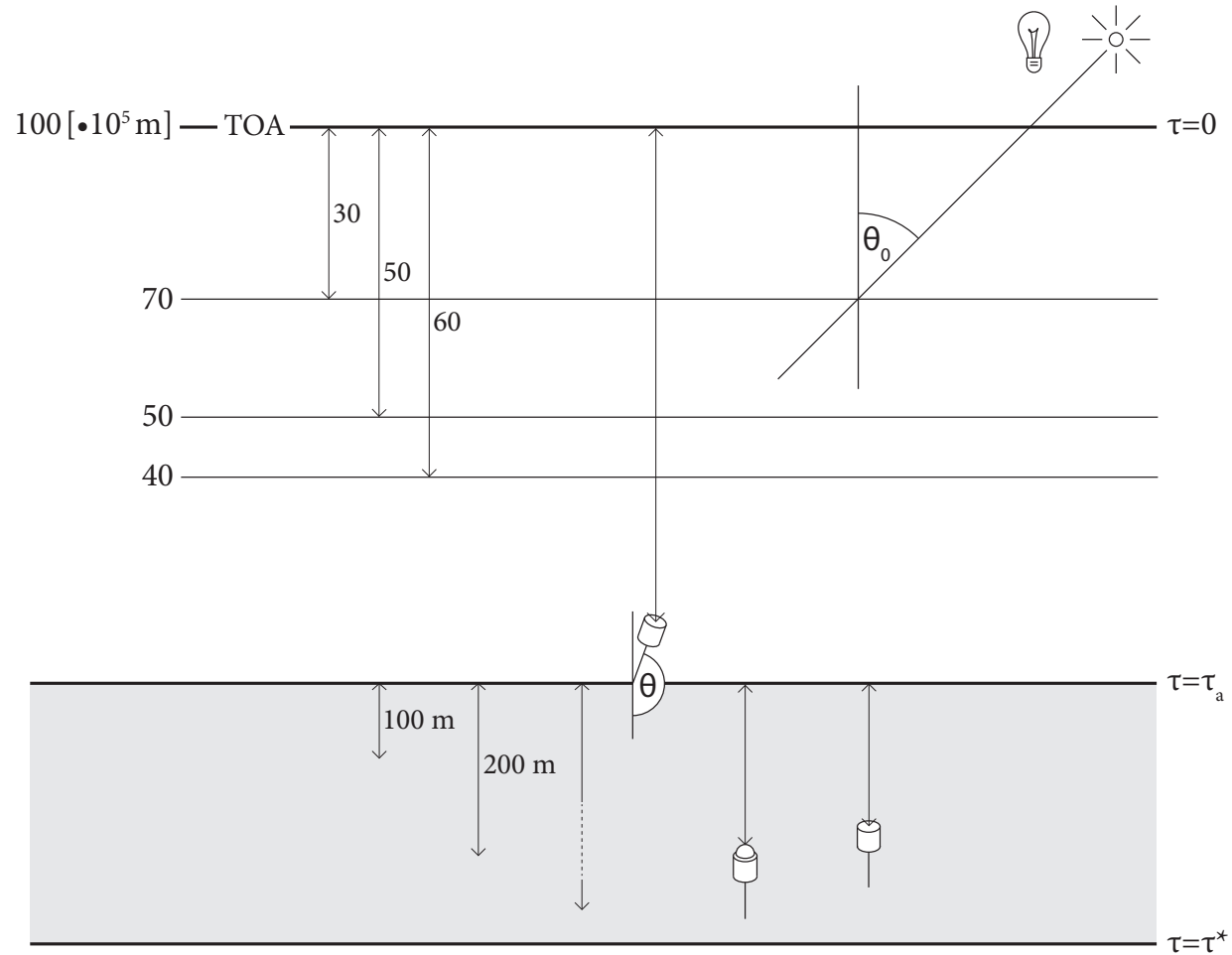

See Appendix 1 (page 19) of User Manual for details.



# AccuRT Examples (3)

## AccuRT examples: Coupled atmosphere-snow system

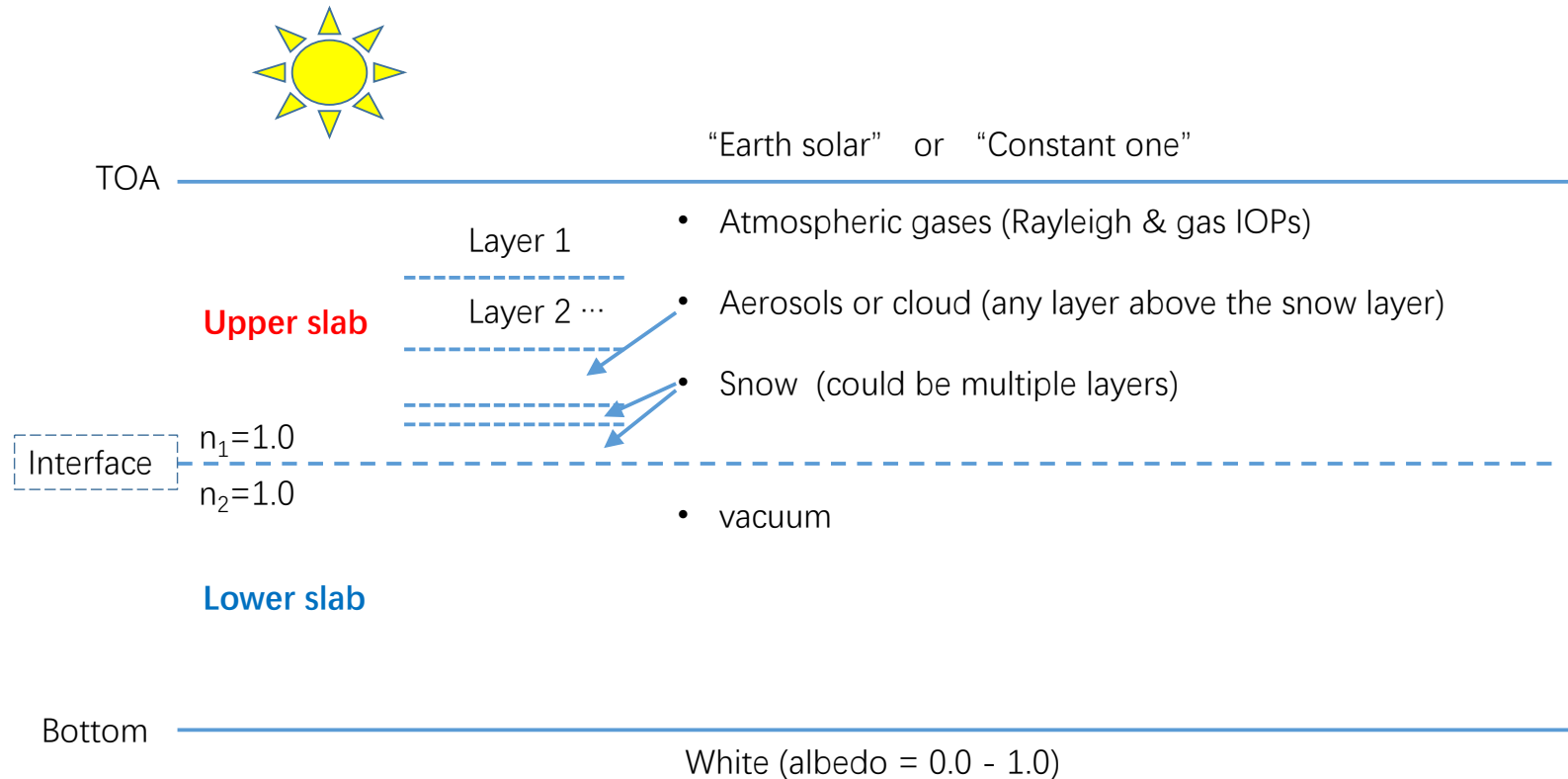

**Note:** We treat snow as a “cloud” on the ground consisting of particles (snow flakes) that scatter and absorb radiation.



# AccuRT Examples (4)

## AccuRT examples: Coupled atmosphere-land system

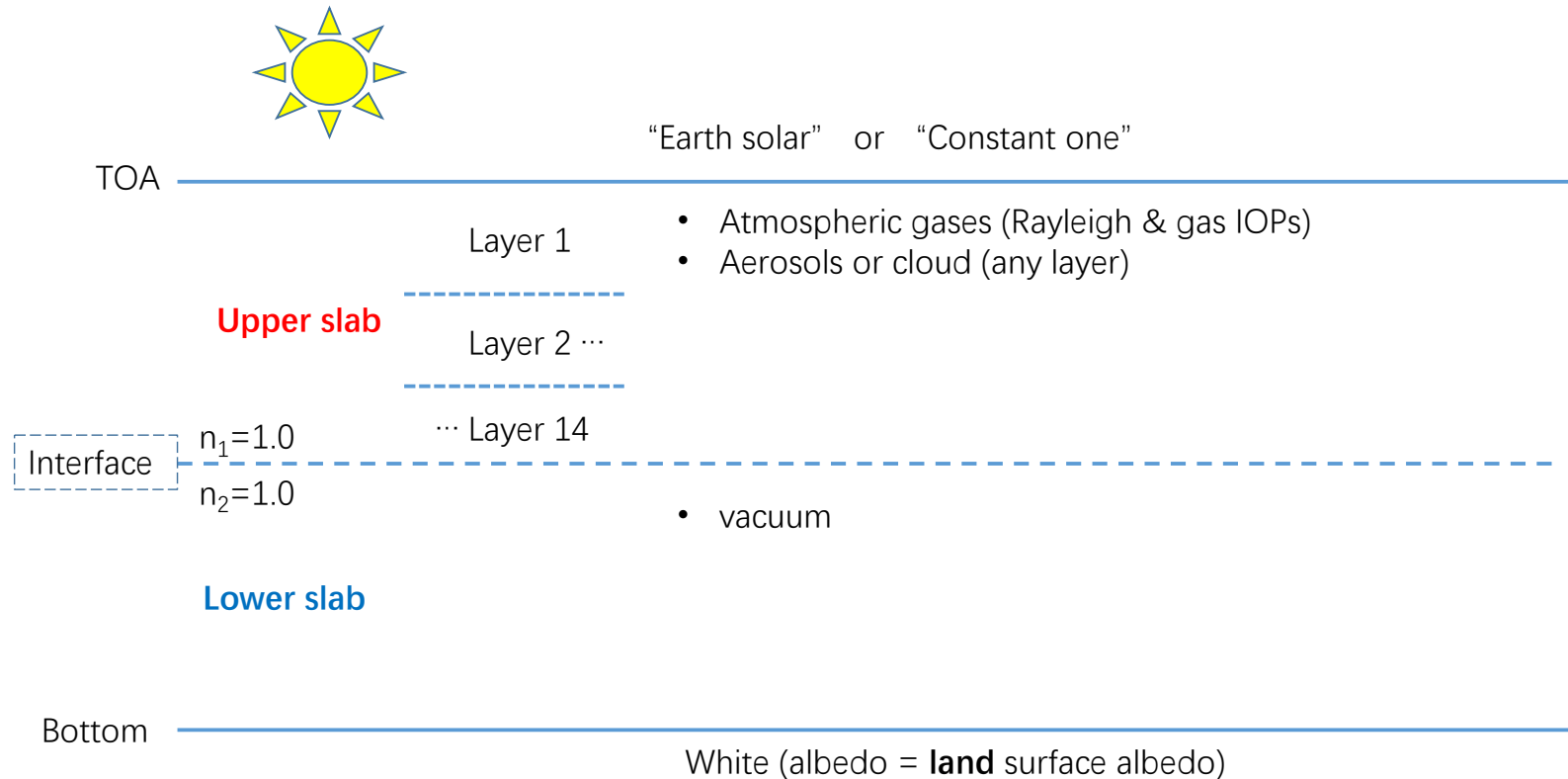

**Note:** We set  $n_2 = n_1$ , put “vacuum” in the lower slab, and specify albedo as a boundary condition at the bottom of the lower slab.





# AccuRT Examples (5)

## AccuRT examples: Coupled atmosphere-ice-ocean system

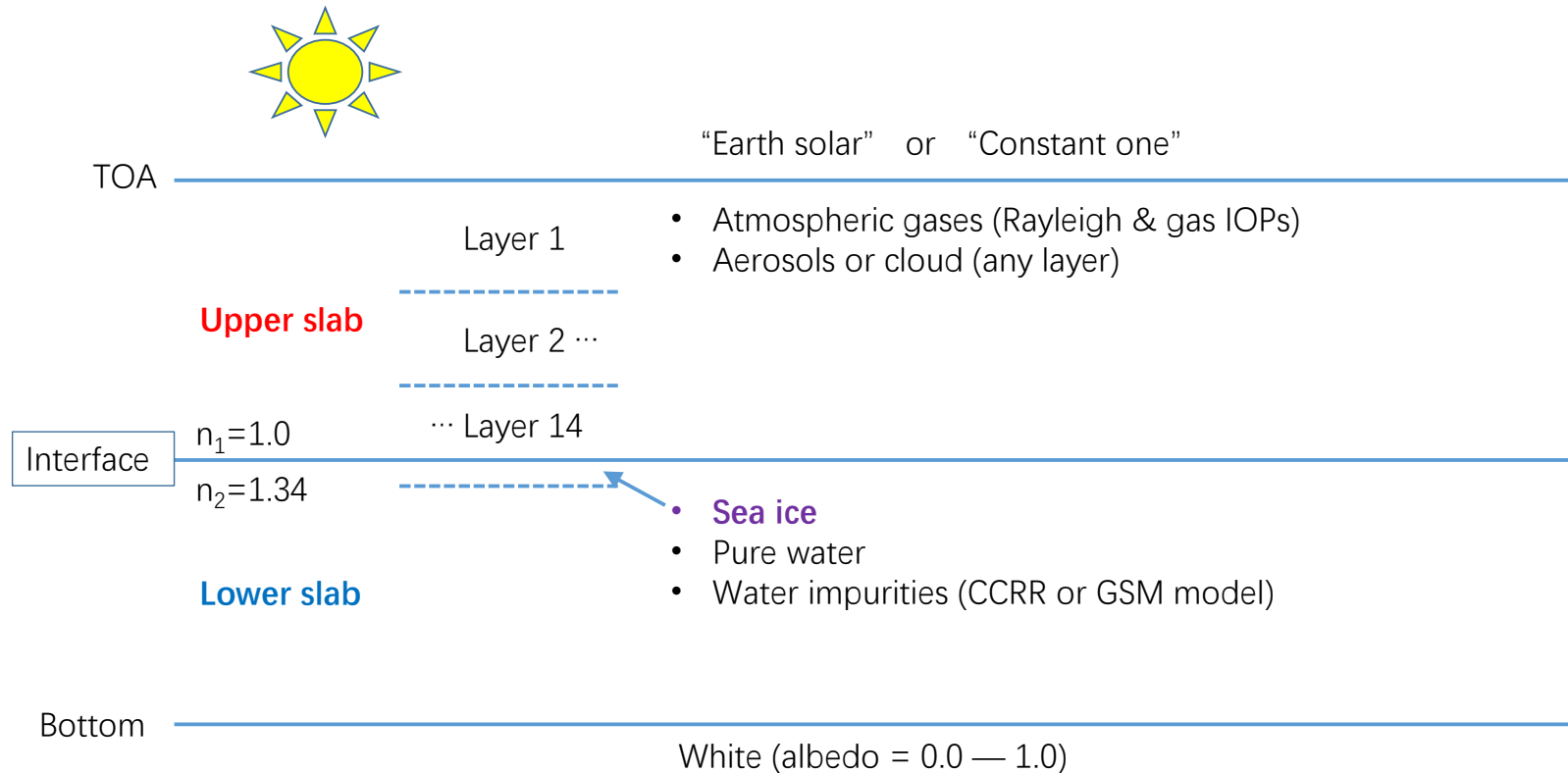

Note: We set  $n_2 = 1.34$ , put **ice** in the top layer of the lower slab, and **water** with embedded impurities underneath (**water** on top of **ice** is also possible).



# Questions – Comments – Suggestions – Further reading?

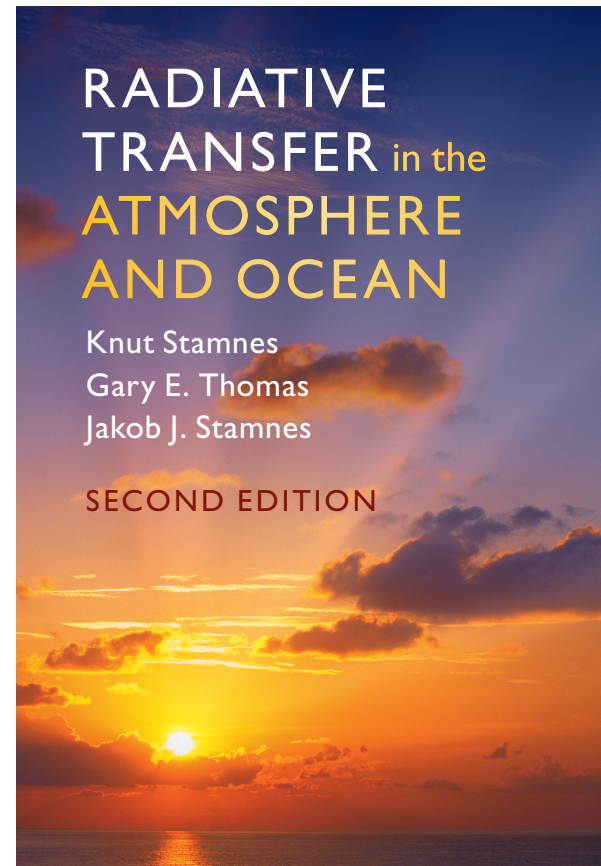
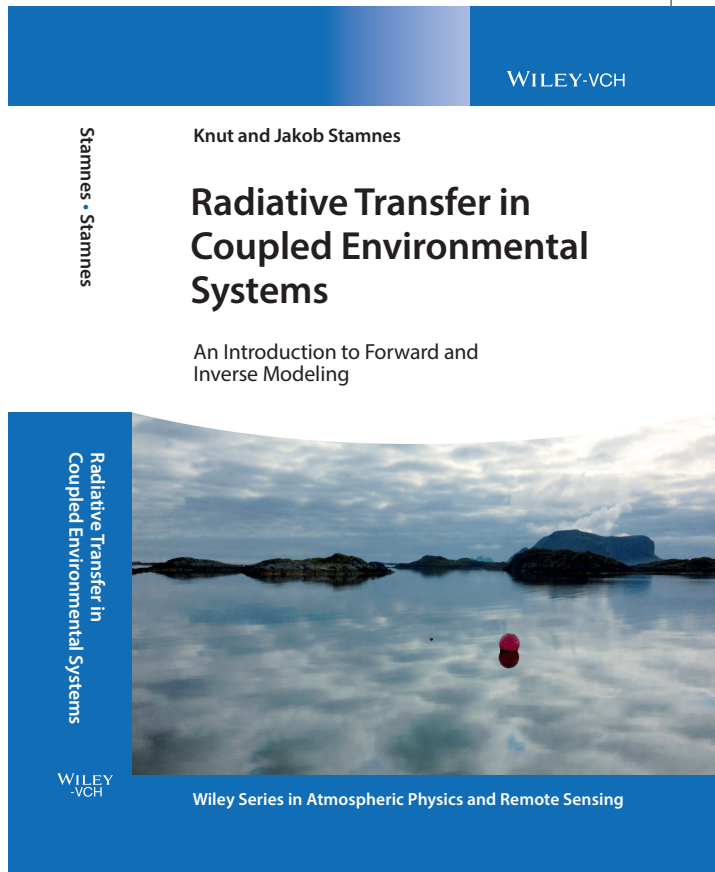

**THANK YOU FOR YOUR ATTENTION!**



**Light and Life Laboratory**  
STEVENS  
Institute of Technology



## Next: Practical matters (important details)....

A “student” version of AccuRT is available to anyone who buys a copy of:

**Stamnes, K., G. E. Thomas, and J. J. Stamnes, Radiative Transfer in the Atmosphere and Ocean, Cambridge University Press, second edition, 2017.**



**Light and Life Laboratory**  
STEVENS  
Institute of Technology



# Installation of VM version of AccuRT

The configuration of this Debian Linux w/ AccuRT Virtual Machine (VM) is as follows (see Section 3 of User manual for details):

1. debian 9 with xfce4 GUI
2. AccuRT v1.0.716
3. openssh enabled
4. Firefox ESR browser
5. GNU Octave (free alternative of MATLAB) 6. FileZilla (free FTP client)

You can **run AccuRT** on this VM and **plot results** using Octave. FileZilla allows you to **transfer your results to other machines** as needed and the command line sftp/scp tools are also available. (Or you can use your VM software to transfer to/from the VM to your host machine.)

To start using this VM version of AccuRT, you need to download Oracle VirtualBox from the following website:

<https://www.virtualbox.org/wiki/Downloads>





# DSCOVOR/EPIC mission: Retrieval of aerosol and ocean products using machine learning methods

Knut Stamnes, Yongzhen Fan<sup>a</sup>, Nan Chen<sup>a</sup>, Wei Li<sup>a</sup>, Charles Gatebe<sup>b,c</sup> and Jakob Stamnes<sup>d</sup>

<sup>a</sup> Light and Life Laboratory, Stevens Institute of Technology, Hoboken, New Jersey, USA

<sup>b</sup> NASA Goddard Space Flight Center, Greenbelt, Maryland, USA

<sup>c</sup> Universities Space Research Association, Columbia, Maryland, USA

<sup>d</sup> University of Bergen, Bergen, Norway



## Why DSCOVR/EPIC for Ocean Color?

The Earth Polychromatic Imaging Camera (EPIC) onboard the Deep Space Climate Observatory (DSCOVR), located at the L1 Lagrangian point between the Earth and the Sun, makes continual spectral measurements of the [entire sunlit Earth surface every 64 - 108 minutes](#) at 317.5, 325, 340, 388, 443, 551, 680, 688, 764 and 780 nm. Therefore, EPIC on DSCOVR

- **has much higher temporal resolution (4-8 images/day for any area of interest) compared to polar orbiting ocean color sensors (1 image/day typically) and is capable of capturing short-term variations of marine ecosystems,**
- **can achieve global coverage compared to geostationary ocean color sensors, such as Geostationary Ocean Color Imager (GOCI), which monitors the ocean around the Korean Peninsula only.**



EPIC enhanced RGB images on 05/03/2018.

From left to right: 06:13 UTC, 07:18 UTC, 08:24 UTC, 09:29 UTC, 10:35 UTC

# Why DSCOVER/EPIC for Ocean Color?

Disadvantages of the EPIC sensor include:

- relatively low spatial resolution (10 – 20 km) compared to existing ocean color sensors ( $\leq 1$  km typically)
- relatively low signal to noise ratio (SNR).

However, products derived from EPIC are suitable for global and regional studies of atmospheric aerosols, the marine ecosystem, and large coastal/inland water bodies, which can reasonably address some of the “Most Important” and “Very Important” Science and Applications objectives in the 2017-2027 Decadal Survey, namely:

- (E-2) What are the fluxes (of carbon, water, nutrients, and energy) between ecosystems and the atmosphere, the ocean and the solid Earth, and how and why are they changing?
- (E-3) What are the fluxes (of carbon, water, nutrients, and energy) within ecosystems, and how and why are they changing?

# Current Atmospheric Correction (AC) for EPIC

The current AC algorithm for DSCOVR/EPIC sensor is **Multi-Angle Implementation of Atmospheric Correction (MAIAC)**, which is **applied globally** to derive surface reflectance. However, MAIAC has a **few issues** over water areas.

## ➤ **No distinction between surface and water body signal**

In water areas, MAIAC retrieved surface reflectance does not distinguish the reflectance of the water surface from that of the water body, which is what the ocean color community needs. In addition, the water IOP model used in MAIAC appears to be over-simplified and cannot represent different types of water, especially in coastal/inland areas.

## ➤ **Negative surface reflectance**

Example on the right (04/02/2017 11:24 UTC) shows negative values in MAIAC surface reflectance at 443, 551, 680, and 780 nm, from left to right. **Note that purple color marks pixels with negative values which exist in every MAIAC L2 product we investigated. But this problem has now been fixed according to MAIAC developers.**

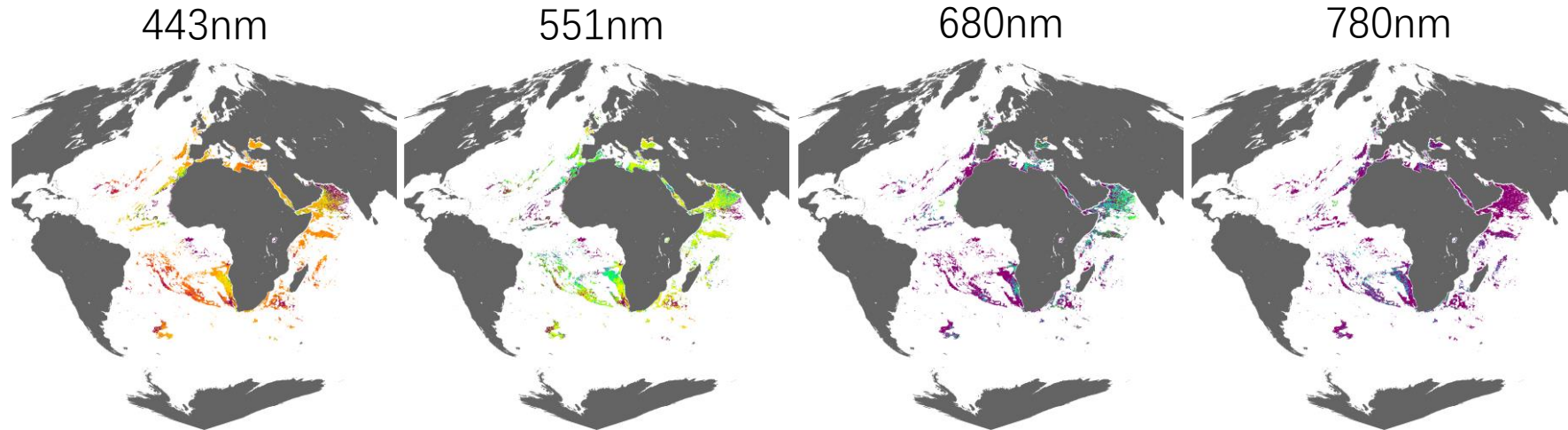

## ➤ **Inaccurate cloud screening**

Example on the right (04/02/2017 12:24 UTC and 04:12 UTC) shows MAIAC cloud mask (CM) results over West coast of Africa and East China Sea. **Note that heavy aerosols over West coast of Africa and turbid coastal waters in East China Sea are misclassified as cloud.**

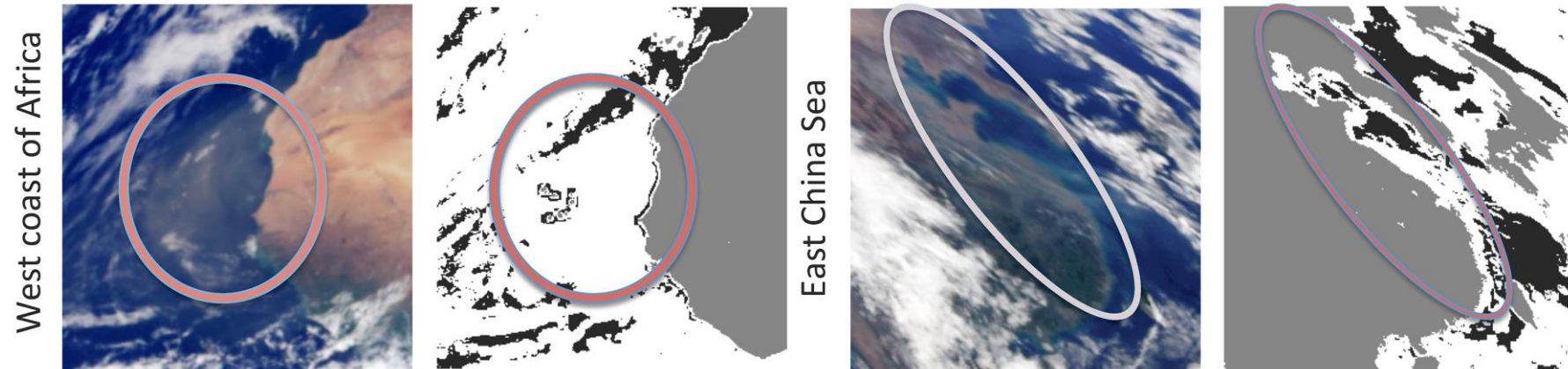



# Standard Atmospheric Correction (AC) for Ocean Color Sensors

**Standard AC algorithms** describe the radiance measured by the satellite sensor as:

$$L_t(\lambda) \doteq L_r(\lambda) + L_a(\lambda) + T(\lambda)L_g(\lambda) + t(\lambda)L_{wc}(\lambda) + t(\lambda)L_w(\lambda)$$

|          |   |
|----------|---|
| $L_t$    | total TOA radiance measured by satellite sensor.                  |
| $L_r$    | radiance due to Rayleigh scattering.                              |
| $L_a$    | radiance due to aerosols, including Rayleigh-aerosol interaction. |
| $L_g$    | radiance due to sun glint.  |
| $L_{wc}$ | radiance due to whitecaps.  |
| $L_w$    | water-leaving radiance.   |
| $T$      | direct atmospheric transmittance.                                 |
| $t$      | diffuse atmospheric transmittance.                                |

The purpose of an AC algorithm is to **derive  $L_w$  from  $L_t$  by removing all the other terms in the equation.**

**Standard AC algorithm for OC sensors may not be applicable to EPIC**, because it requires two NIR or SWIR bands to retrieve aerosol contributions to radiances. **The two EPIC NIR bands, at 764 and 779 nm, are not suitable for this purpose because:**

- 764 nm is strongly affected by Oxygen A-band absorption.
- The two bands are spectrally close, therefore has lower sensitivity to aerosol models.
- The black ocean assumption fails in turbid coastal/inland water areas.

**A new AC algorithm is needed in order to produce accurate ocean color products from EPIC.**

# The Multilayer Neural Network (MLNN) AC

- The **MLNN AC** algorithm is a spectral matching algorithm based on the **spectral similarity between Rayleigh corrected TOA radiances ( $L_{rc}$ ) and the water-leaving radiances ( $L_w$ )**. Therefore it **does not require the aerosol radiances to be retrieved**.
- The MLNN AC relies on **extensive and reliable simulations** from a **coupled atmosphere-ocean RT model (AccuRT)** that accurately computes multiple scattering and BRDF effects between the atmosphere and ocean.
- **Multiple flexible aerosol and water IOP models** are used in the RT simulations to create a comprehensive global dataset that is **representative of most marine and aerosol conditions**.
- **Realistic input parameter distributions** for the aerosol and water IOP models are obtained by **analyzing level-3 global ocean color products** from current ocean color sensors.

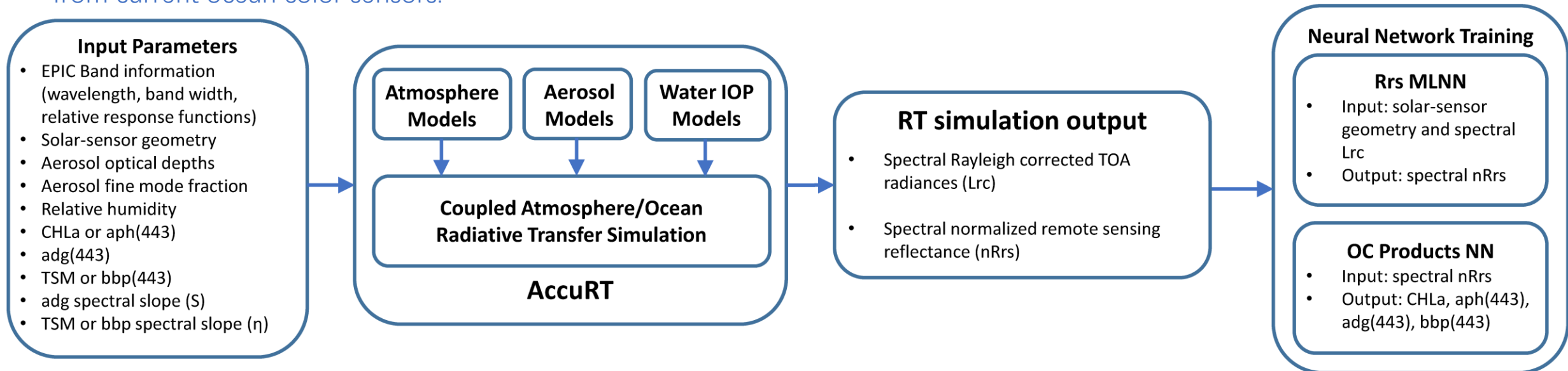
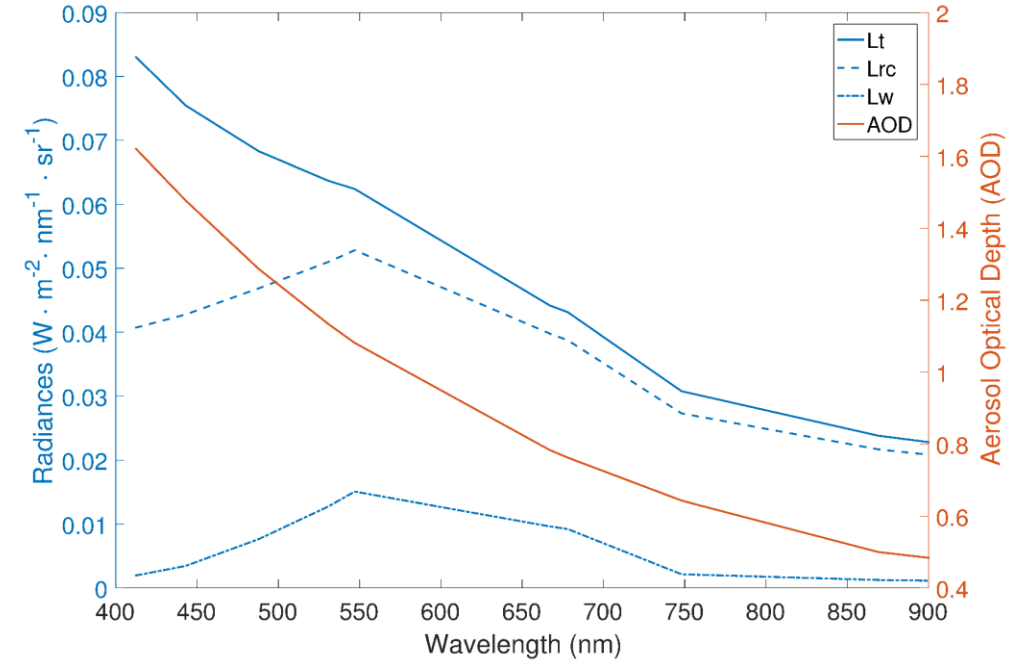

# OC-SMART introduction

Ocean Color - Simultaneous Marine and Aerosol Retrieval Tool (**OC-SMART**) is a toolbox designed to retrieve **aerosol and ocean color products** from satellite remote sensing images. It utilizes **multilayer neural networks** (MLNNs) driven by **extensive radiative transfer simulations** using our **coupled atmosphere-ocean RT model** (AccuRT) to perform atmospheric correction (AC).

## Compelling features of OC-SMART:

- **Multi-sensor support.** OC-SMART currently supports **Aqua/MODIS, SNPP/VIIRS, SeaWiFS, Sentinel-2A&B/MSI, Sentinel-3/OLCI, Landsat-8/OLI, COMS/GOCI, GCOM-C/SGLI.**
- **Products: spectral  $R_{rs}$ , CHLa, spectral ocean IOPs** (aph, adg and bbp) and **spectral AODs.**
- **Global application:** OC-SMART is **applicable in both open ocean and coastal/inland waters.**
- **Complete resolution of the negative water-leaving signal issue** which plagues many other AC algorithms.
- **Flexible sensor band configurations** (e.g. **OC-SMART does not require SWIR bands** in turbid water areas).
- **Improved retrievals of water-leaving radiances,** especially in complex coastal and inland water areas.
- **Superior cloud screening** over water.
- **Applicable in extreme conditions** such as heavy aerosol loadings, extremely turbid water, etc.
- **Robust and resilient to contamination of sunglint and adjacency effects** of land or cloud edges
- **Fast,** suitable for operational use (about **7 times faster than SeaDAS**).
- **Easy-to-use Python package available.**

# OC-SMART – Validation on SeaWiFS (1997-2010)

- OC-SMART is **extensively validated** for both open ocean and coastal areas using SEABASS and AERONET-OC data.
- OC-SMART improves  $R_{rs}$  and CHLa retrievals globally and produces **no negative**  $R_{rs}$  values.

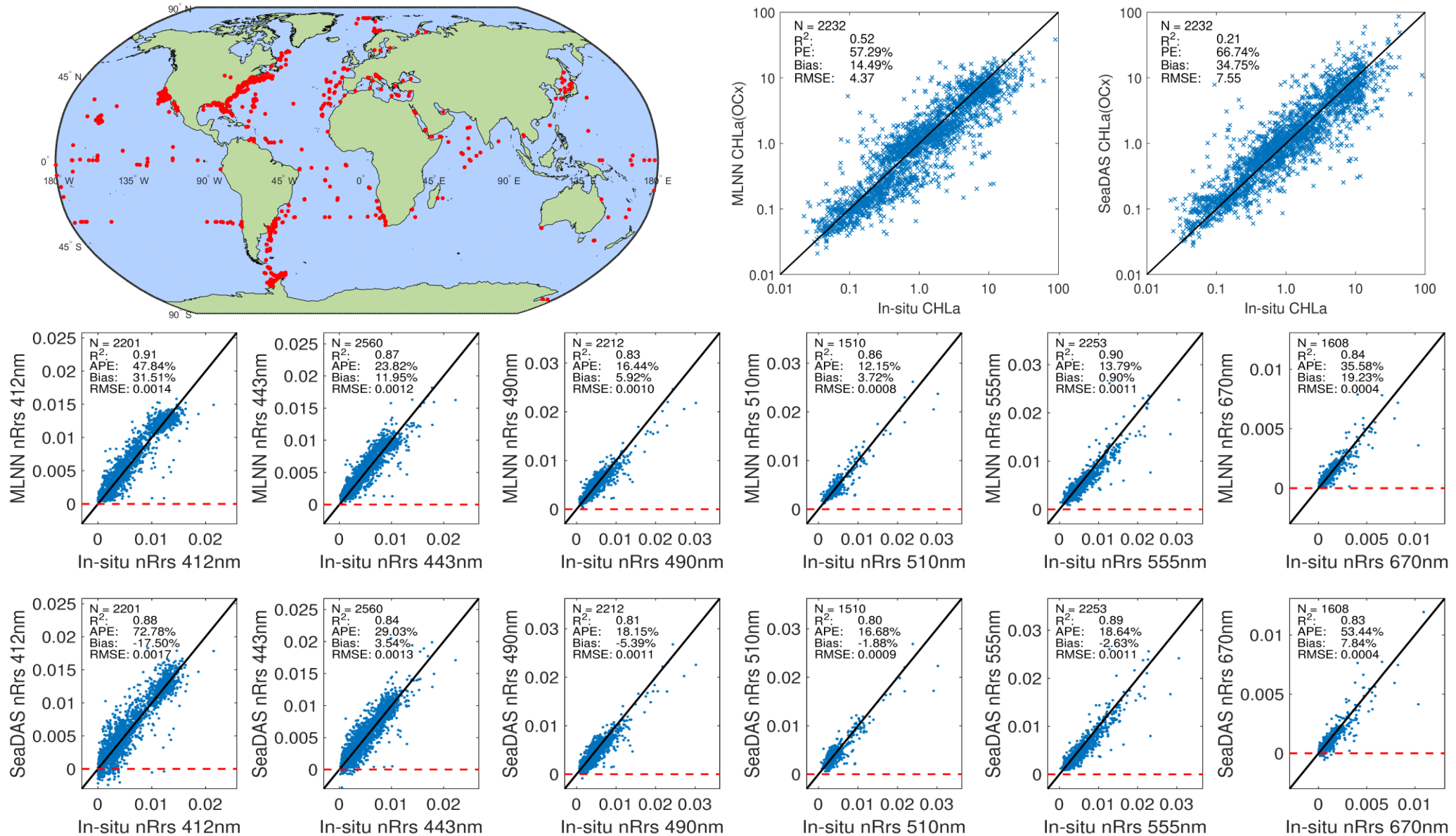

# OC-SMART – Validation on VIIRS (2012-2017)

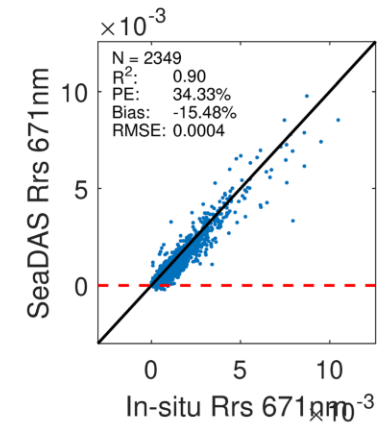
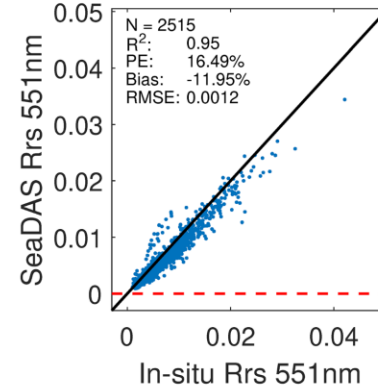
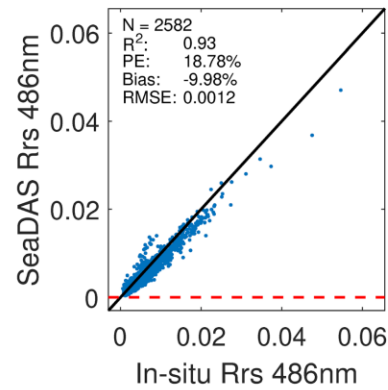
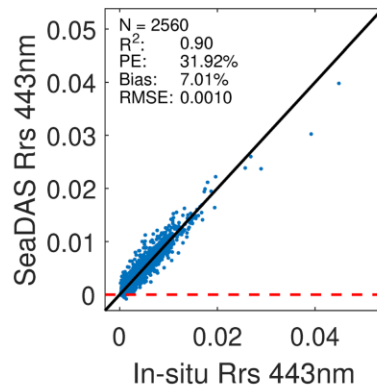
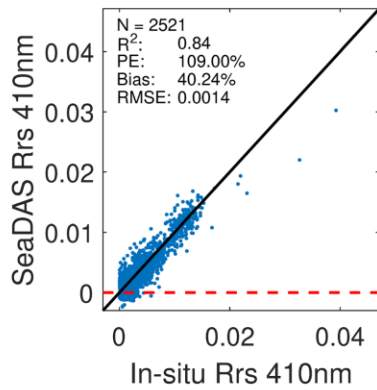
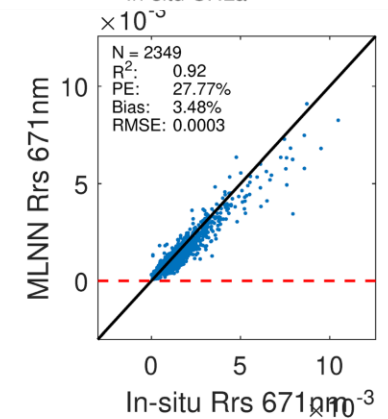
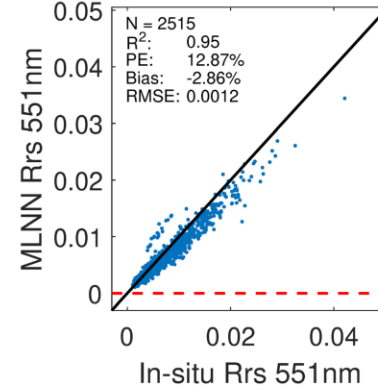
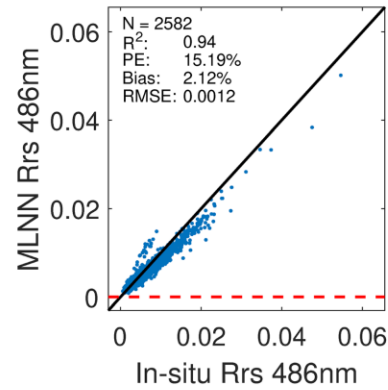
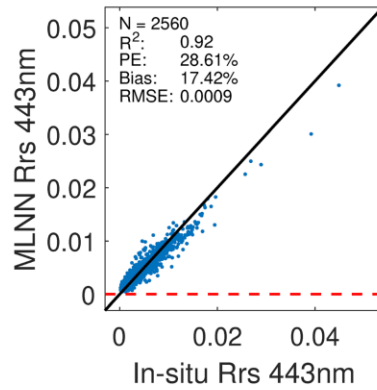
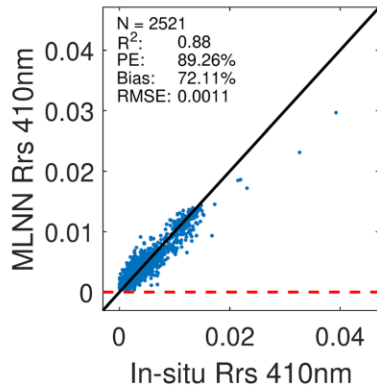
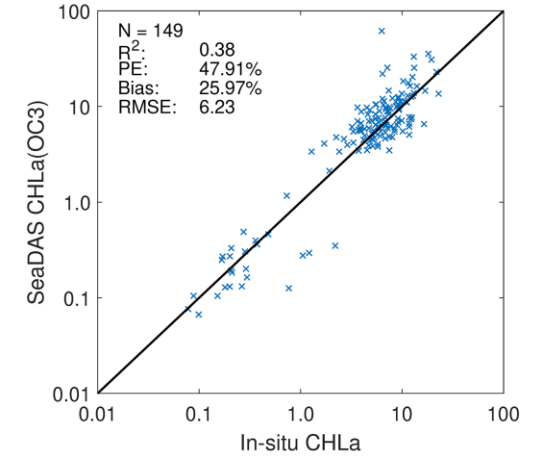
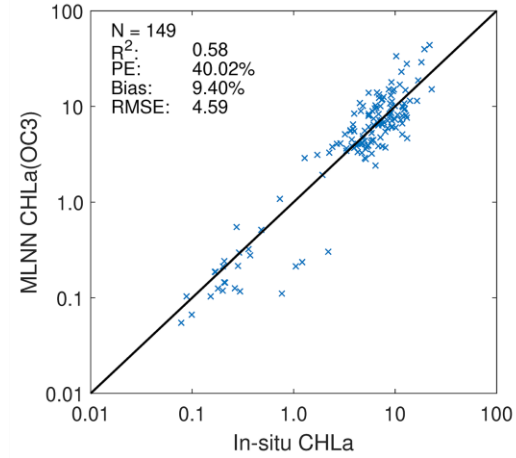
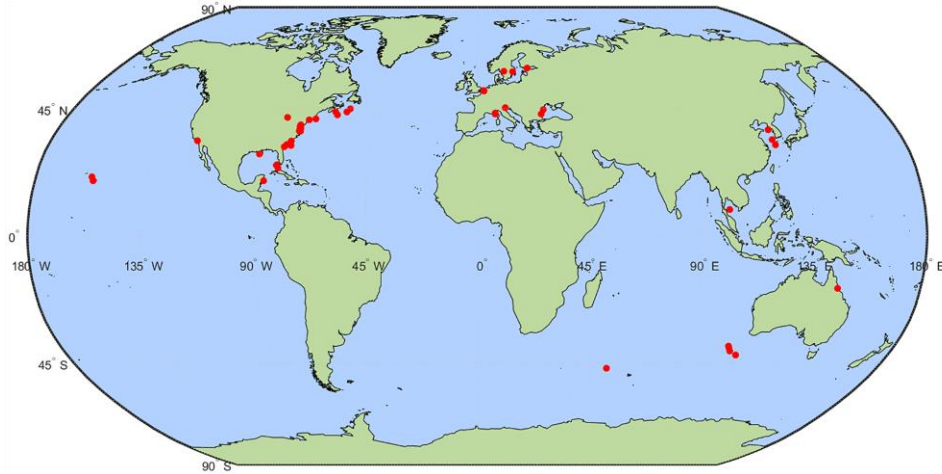

# The Multilayer Neural Network (MLNN) AC for EPIC

## EPIC Level 1B Data

### Ancillary Data

- TOA spectral radiance in 10km X 10km spatial resolution at 388, 443, 551, 680 and 780 nm.
- Ozone, surface pressure, wind speed, humidity

## Pre-processing

- Land/water classification
- Cloud screening (Cloud NN)
- Sunglint screening
- Atmospheric gases transmittance correction
- Rayleigh optical depth correction
- Whitecaps radiance correction
- Rayleigh radiance removal

## MLNN AC

- TOA radiance out of range test
- TOA radiance spectral shape test
- Rrs MLNN
- CHLa and ocean IOP retrieval

## Final Products

- Normalized remote sensing reflectance (nRrs) at 388, 443, 551, 680 and 780nm.
- Chlorophyll a concentration (CHLa)
- Ocean IOPs (aph443, adg443 and bbp443)

- **5 bands** are selected to develop MLNN AC for EPIC, **388, 443, 551, 680, and 780 nm**.
- **688 and 764 nm** are not used for AC due to strong Oxygen absorption; however, **could be useful for cloud detection**.
- **Bandwidth, band relative response functions, and band SNR** values are **taken into account in the RT simulations**.
- **Aerosol models from SeaDAS and OPAC 4.0** are used to simulate various aerosol conditions including haze and light sand storms.
- **3 water IOP models (modified GSM, modified CCRR, and MAG02)** are used to simulate marine conditions, such as clear open ocean, algal blooms, CDOM rich inland waters, highly turbid estuary areas, etc.
- **Ocean color products include Rrs values at 388, 443, 551, 680, and 780 nm, CHLa and spectral ocean IOP products (aph, adg and bbp), aerosol products include AOD at 388, 443, 551, 680, and 780 nm.**
- **The “raw” ocean color and AOD products have the same spatial resolution as the L1B data, and the daily averaged OC and AOD products will be converted on to a 10 km X 10 km sinusoidal grid.**

# Vicarious Calibration for EPIC using MOBY data

➤ The vicarious calibration of EPIC using MOBY data significantly improved  $R_{rs}$  retrievals.

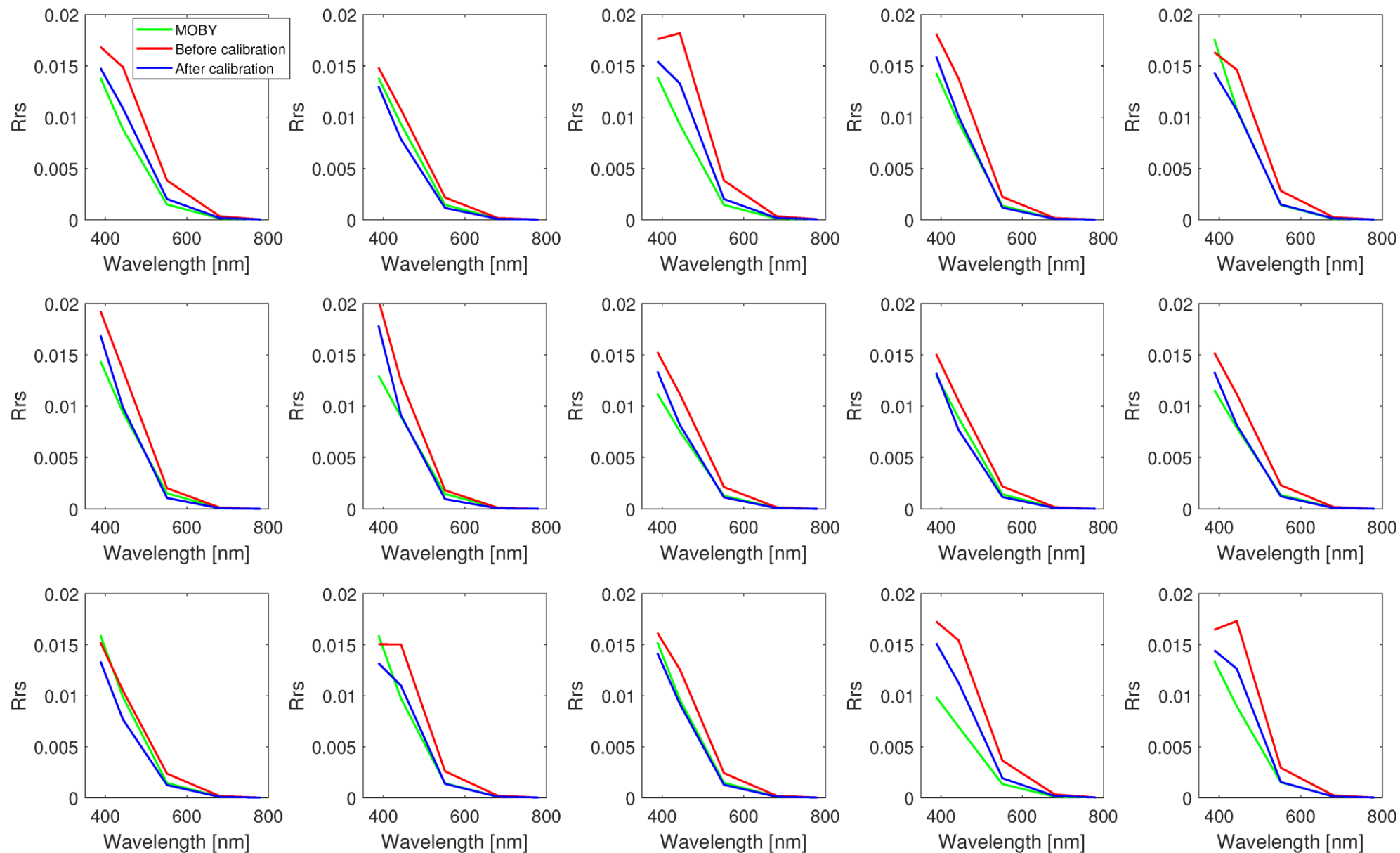

# Remote sensing reflectance ( $R_{rs}$ ) from EPIC using MLNN AC (05/23/2018 05:54:30)

EPIC RGB



Rrs 388nm

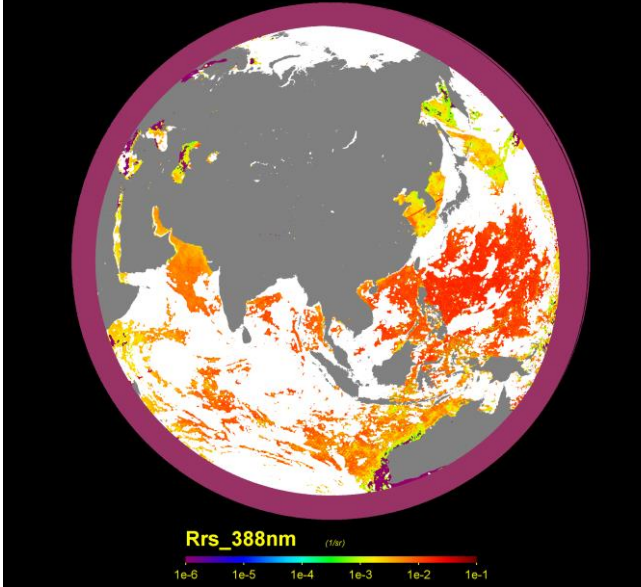

Rrs 443nm

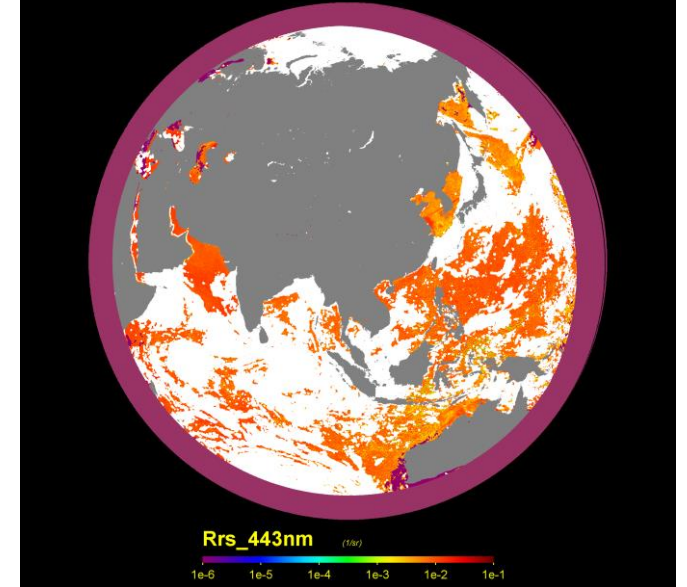

Rrs 551nm

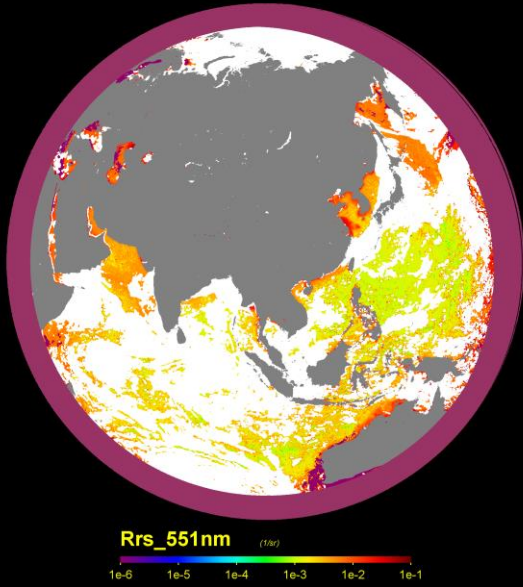

Rrs 680nm

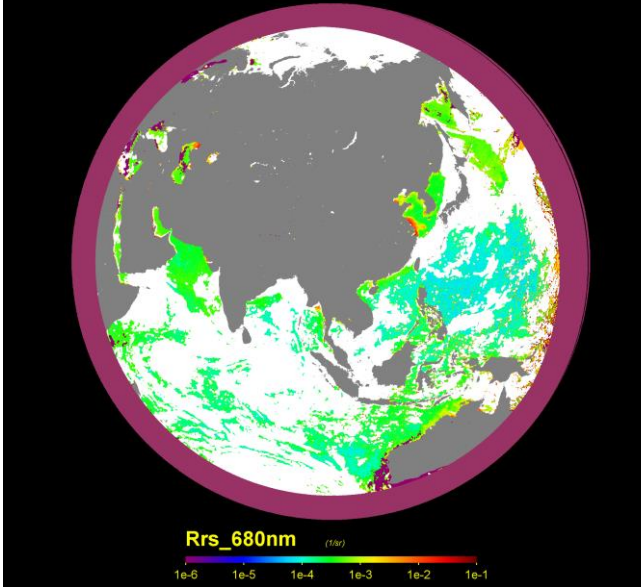

Rrs 780nm

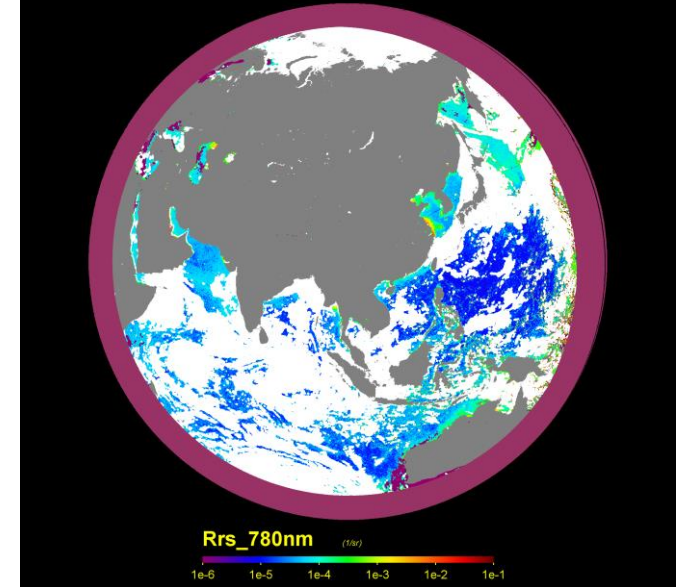



# CHLa and ocean IOP products from EPIC using MLNN AC (05/23/2018 05:54:30)

Chlorophyll a  
(CHLa)

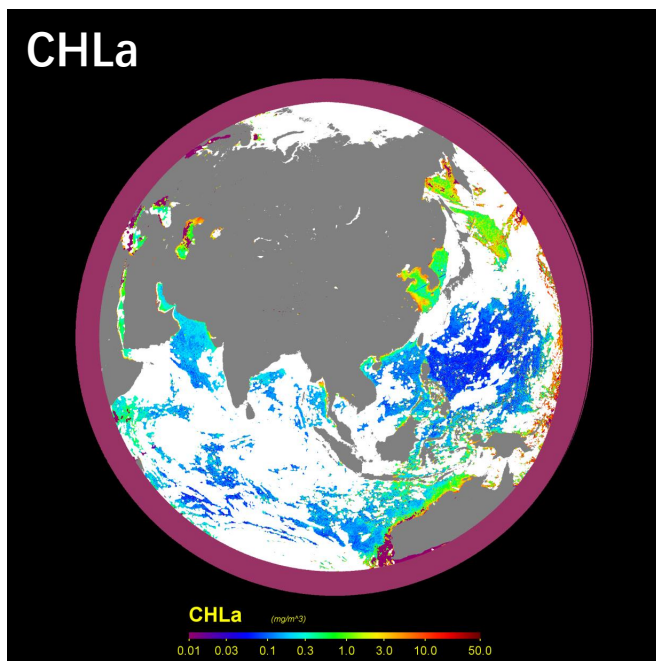

Absorption of  
phytoplankton at  
443 nm (aph443)

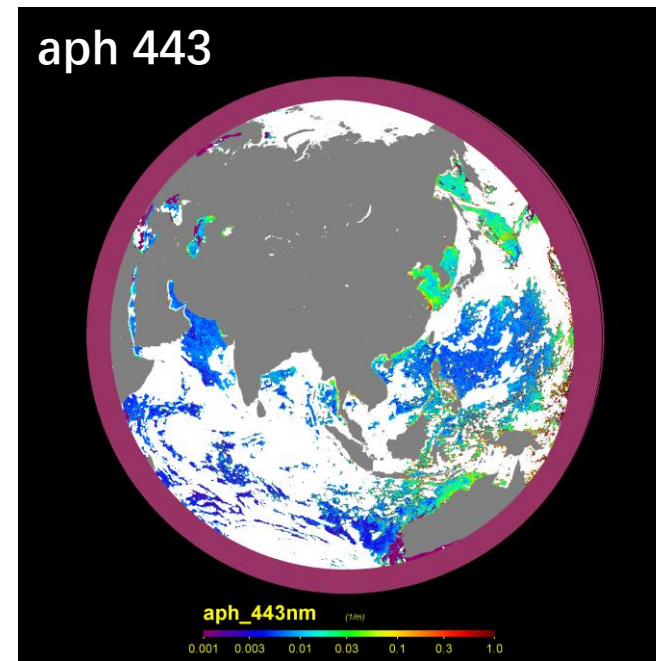

Absorption of  
CDOM and detritus  
at 443 nm (adg443)

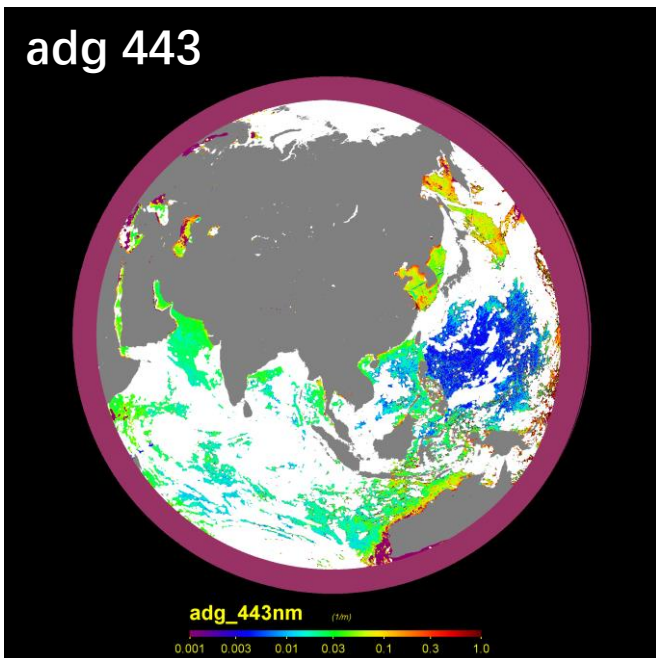

Particulates  
backscattering at  
443 nm (bbp443)

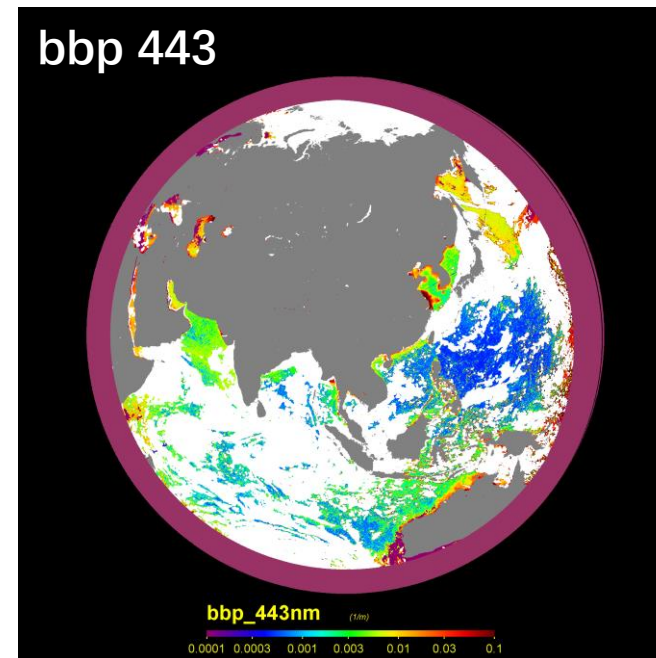

# Comparison of CHLa between EPIC and MODIS/VIIRS (05/23/2018)

➤ The CHLa retrieval from EPIC using MLNN AC shows very good agreement with MODIS and VIIRS results.

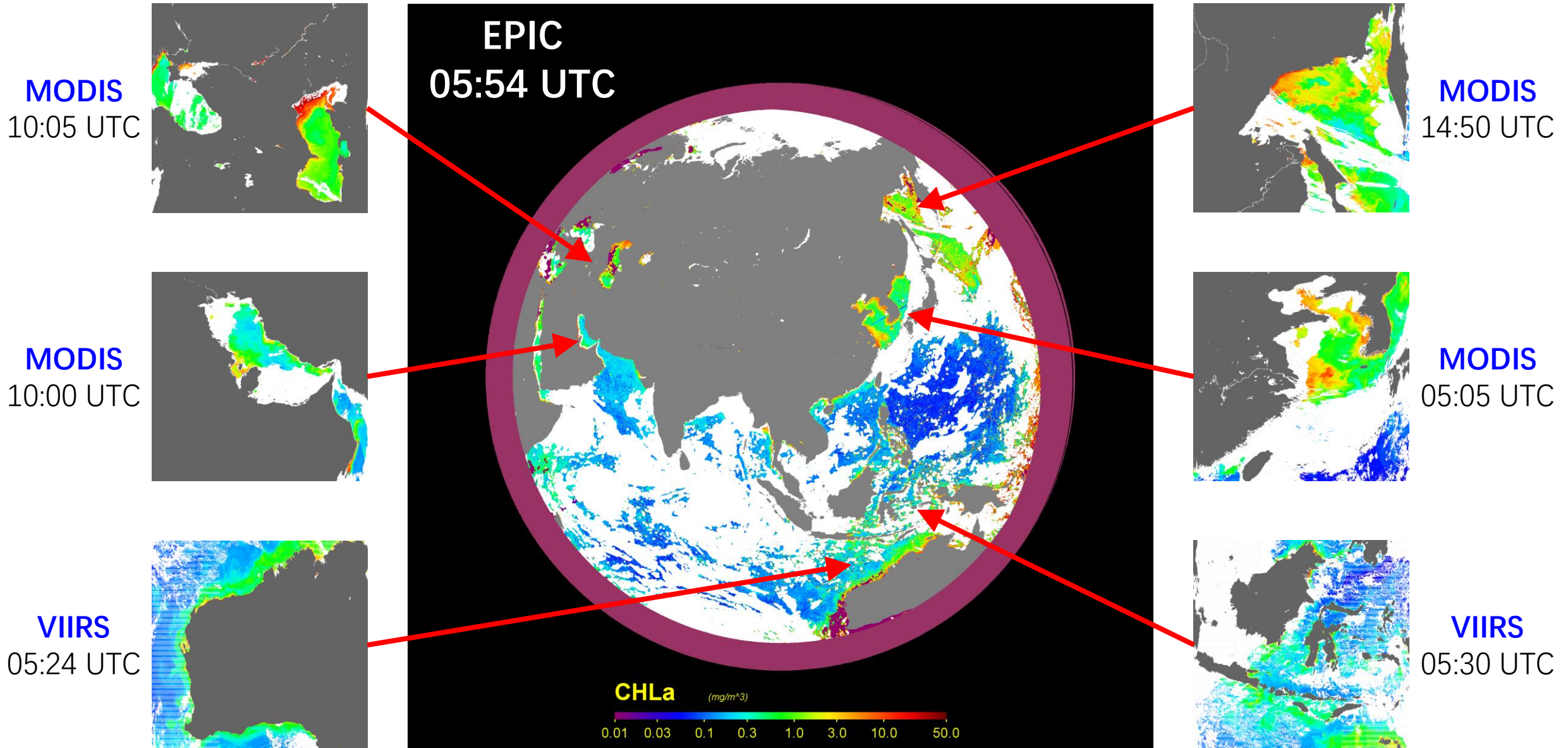

# Aerosol optical depth (AOD) from EPIC using MLNN AC (05/23/2018 05:54:30)

EPIC RGB



AOD 388nm

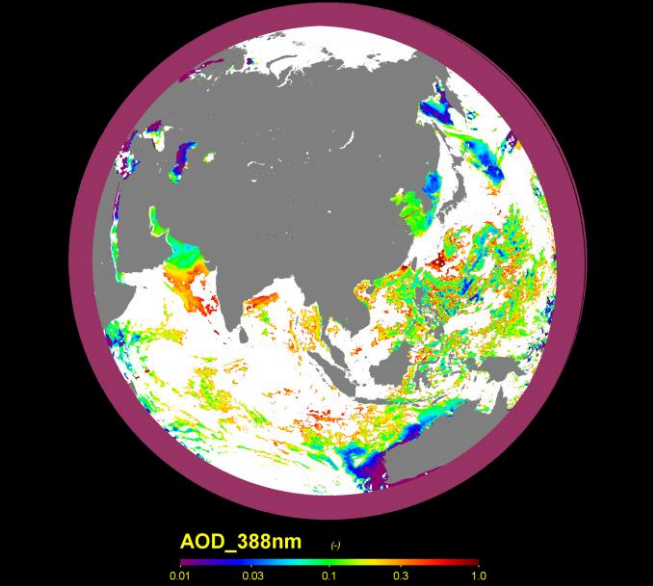

AOD 443nm

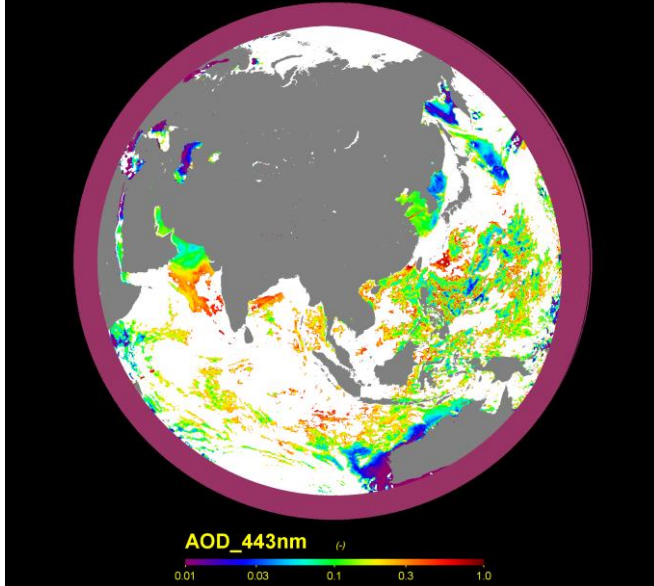

AOD 551nm

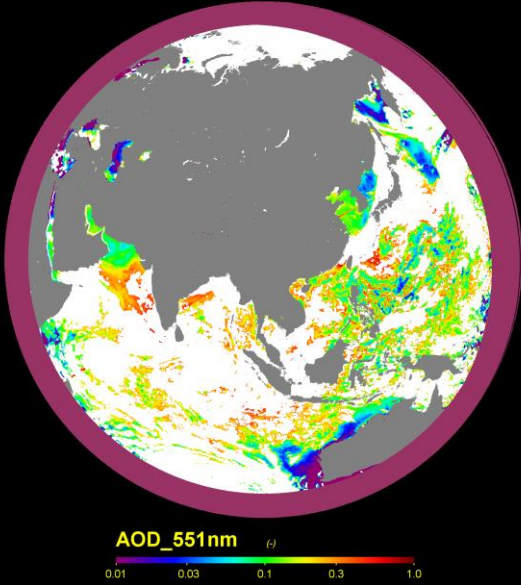

AOD 680nm

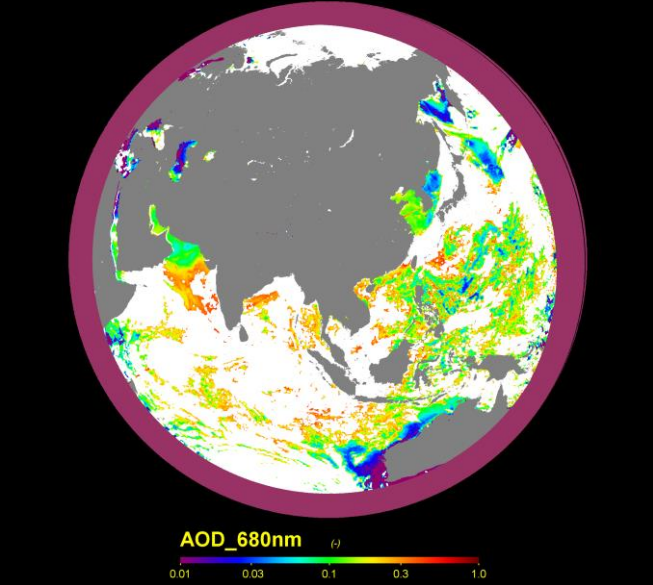

AOD 780nm

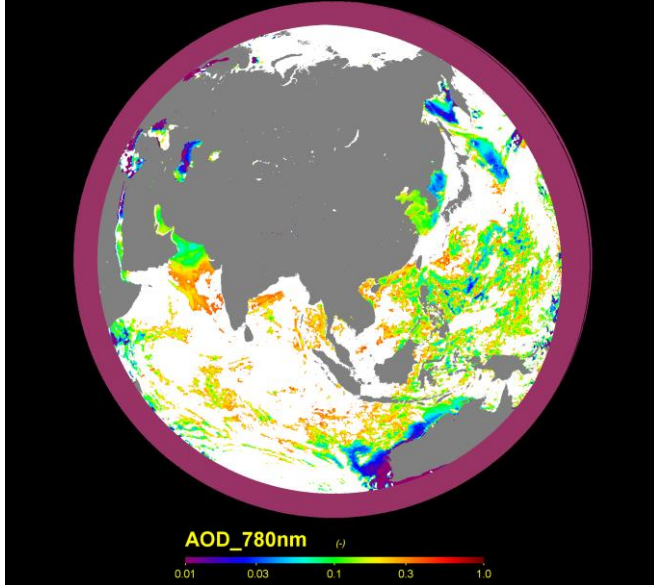

# EPIC Daily $R_{rs}$ values from MLNN compared with MODIS+VIIRS (05/23/2018)

- The daily  $R_{rs}$  retrieval from EPIC using MLNN AC shows **much better spatial coverage** than MODIS+VIIRS retrieval.
- The daily  $R_{rs}$  retrieval from EPIC using MLNN AC shows **very good agreement** with MODIS/VIIRS retrieval.

MLNN daily composition

MODIS+VIIRS daily composition

443 nm

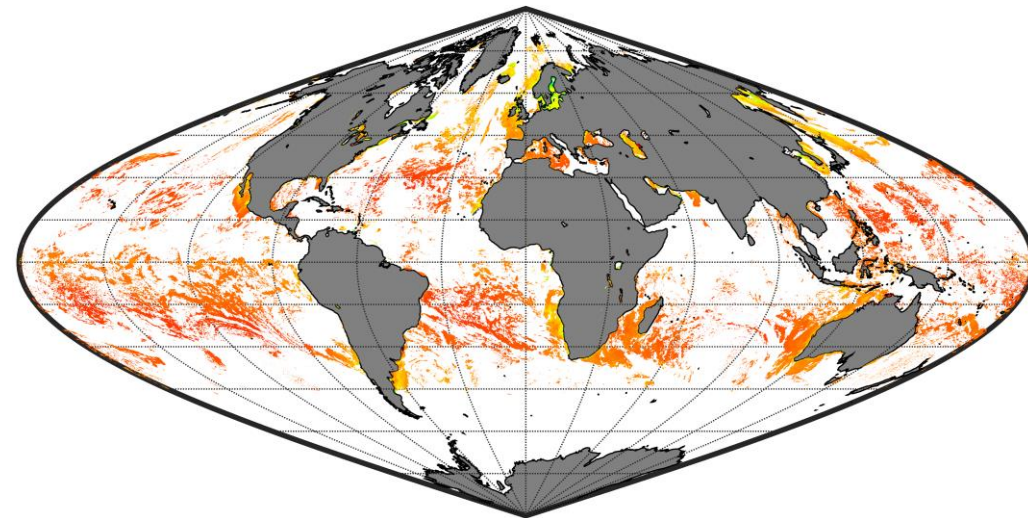
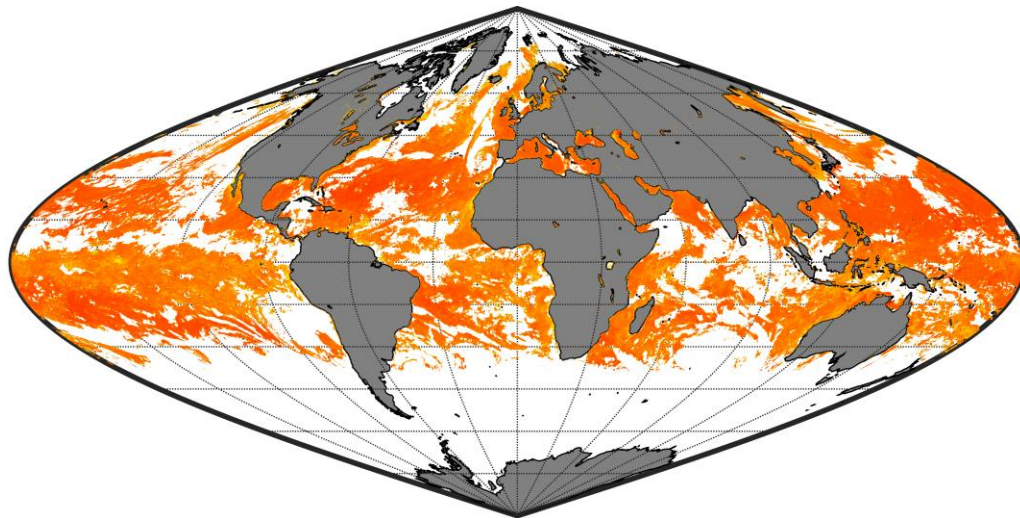

551 nm

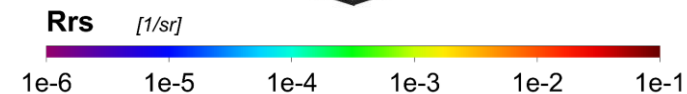
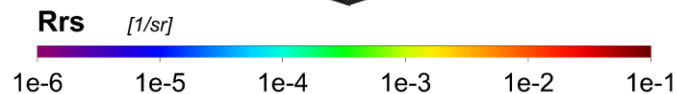
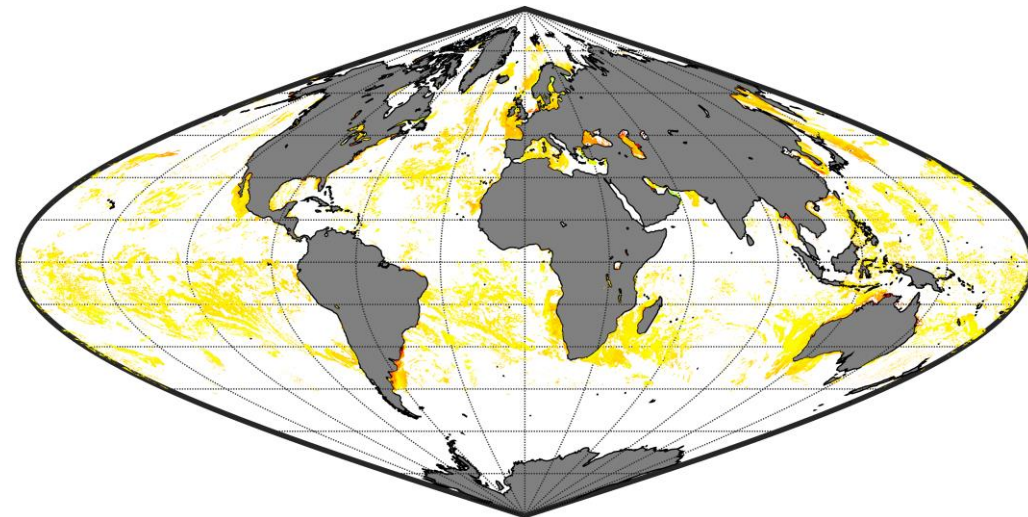
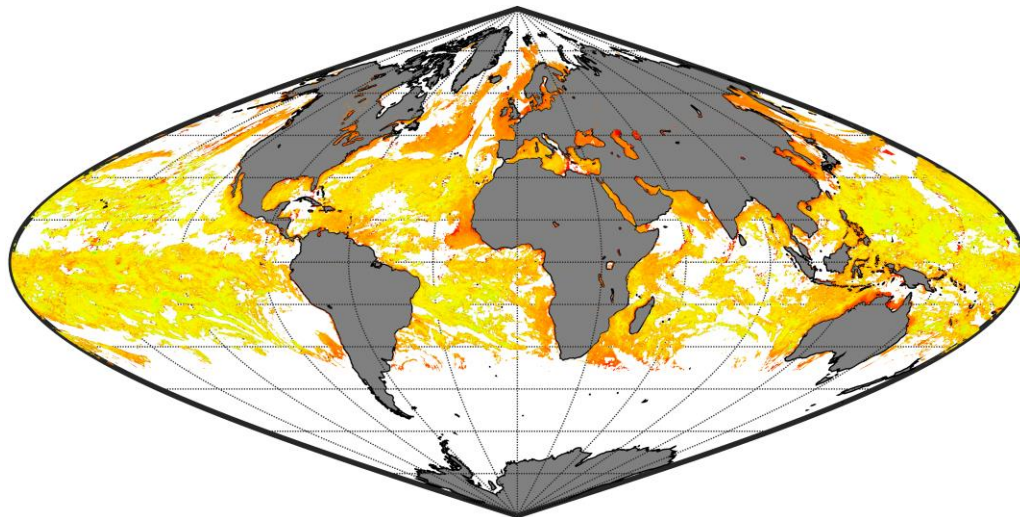

# EPIC Daily $R_{rs}$ values from MLNN compared with MODIS+VIIRS (05/23/2018)

- The daily  $R_{rs}$  retrieval from EPIC using MLNN AC shows **much better spatial coverage** than MODIS+VIIRS retrieval.
- The daily  $R_{rs}$  retrieval from EPIC using MLNN AC shows **very good agreement with MODIS/VIIRS retrieval**.

MLNN daily composition

MODIS+VIIRS daily composition

680 nm

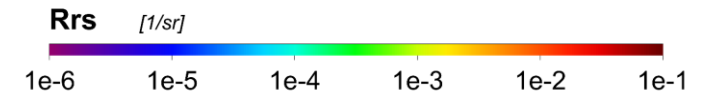
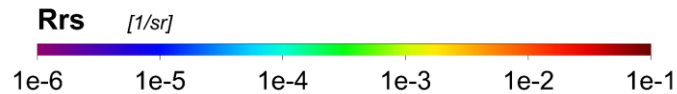
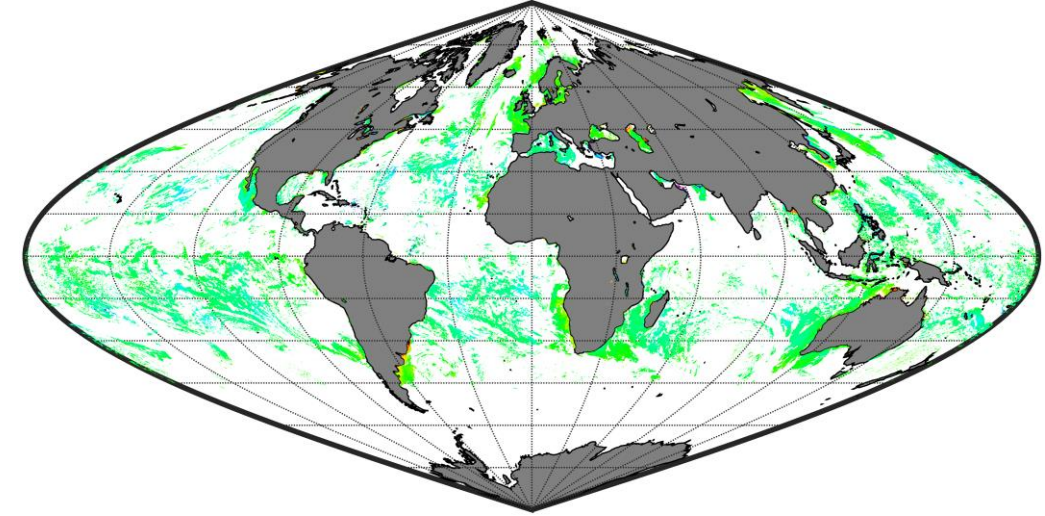
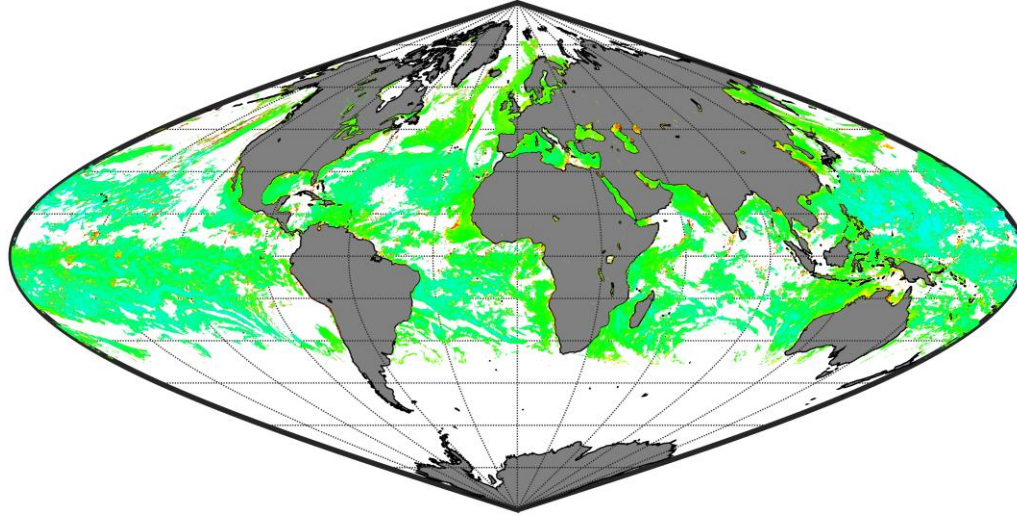

# EPIC Daily OC Products from **MLNN** compared with **MODIS+VIIRS** (05/23/2018)

- The daily CHLa and aph443 from EPIC using MLNN AC shows **much better spatial coverage**.
- The daily CHLa and aph443 from EPIC using MLNN AC shows **very good agreement** with MODIS/VIIRS retrievals.

**MLNN** daily composition

**MODIS+VIIRS** daily composition

CHLa

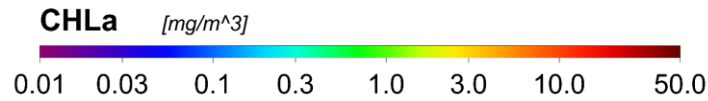
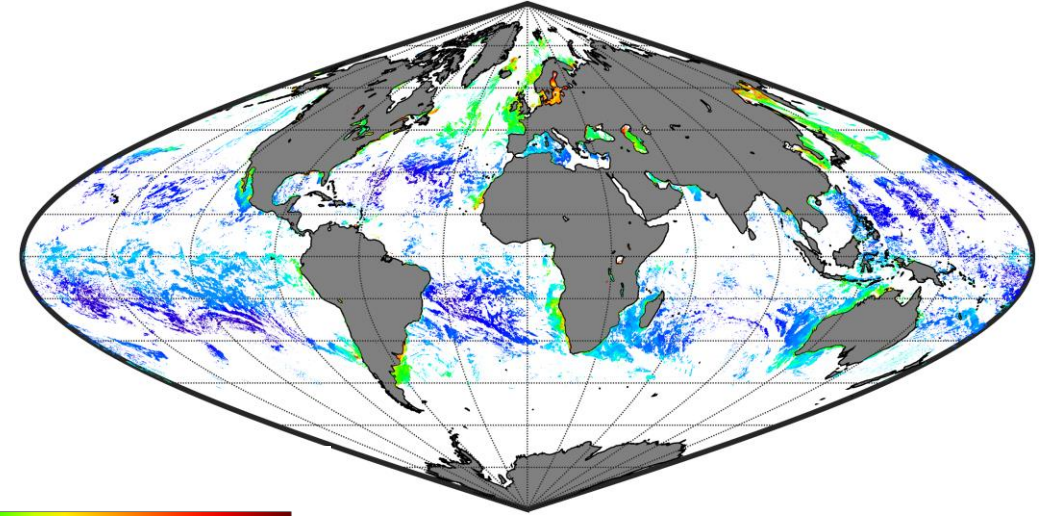
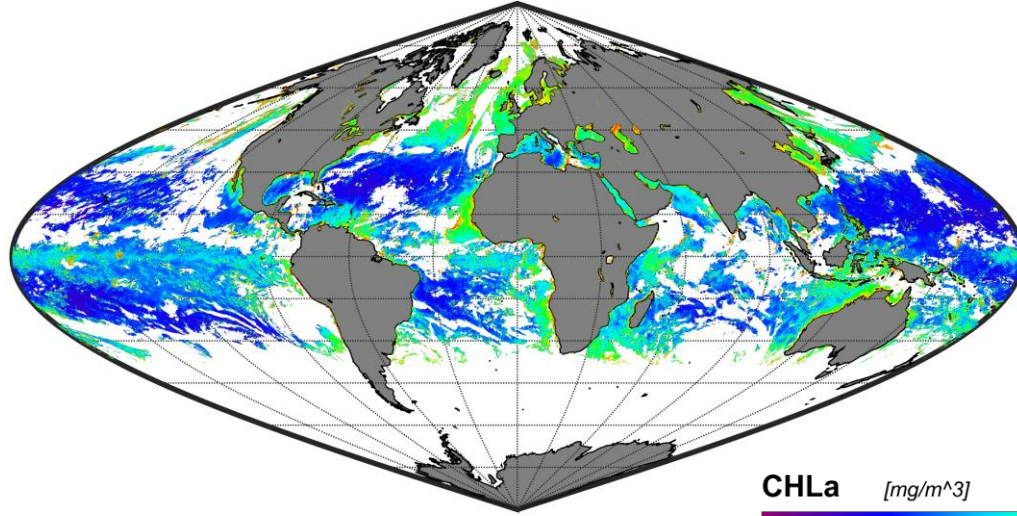

aph443

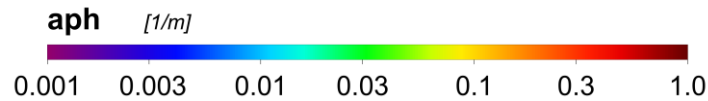
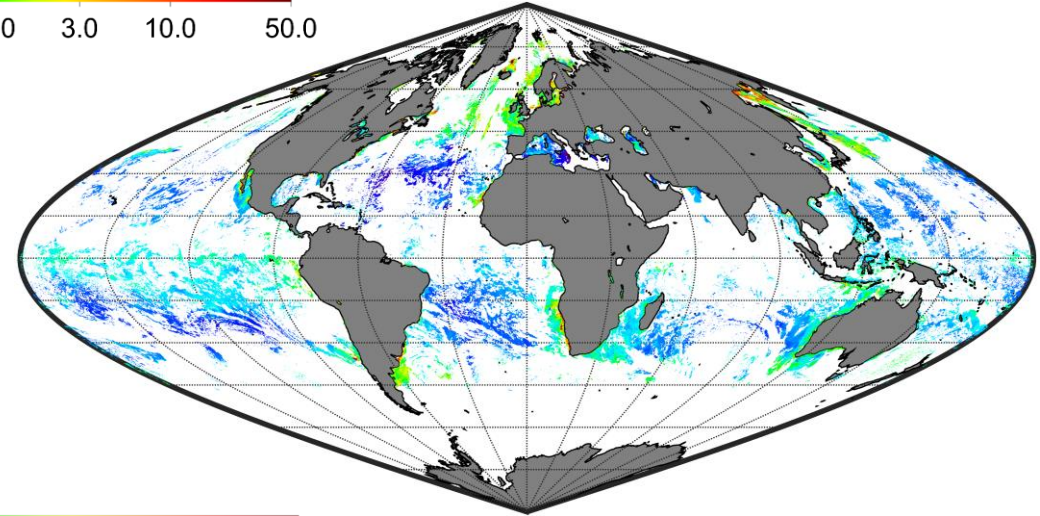
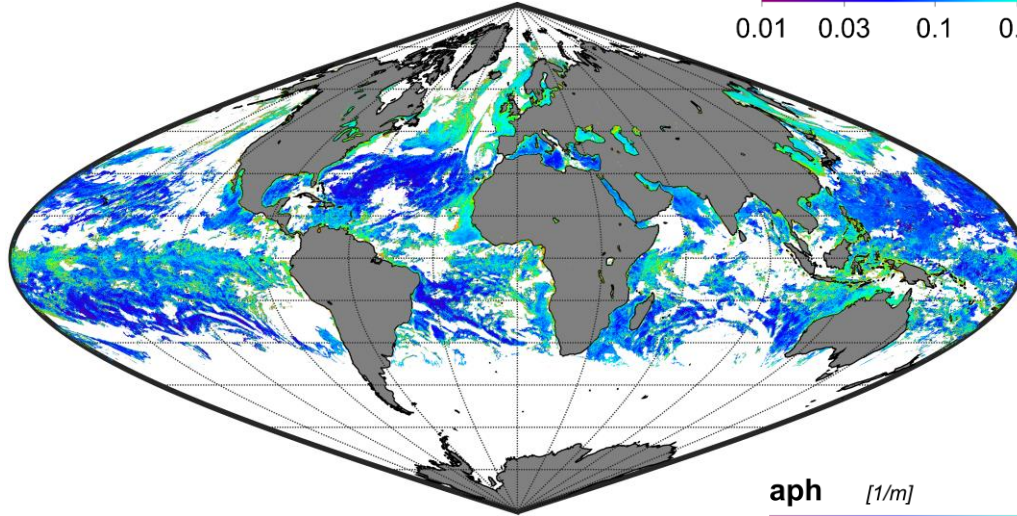

# EPIC Daily OC Products from **MLNN** compared with **MODIS+VIIRS** (05/23/2018)

- The daily adg443 and bbp443 from EPIC using MLNN AC shows **much better spatial coverage**.
- The daily adg443 and bbp443 from EPIC using MLNN AC shows **similar spatial pattern** as MODIS/VIIRS retrievals.

**MLNN** daily composition

**MODIS+VIIRS** daily composition

adg443

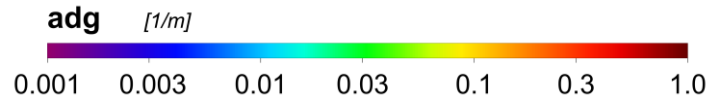
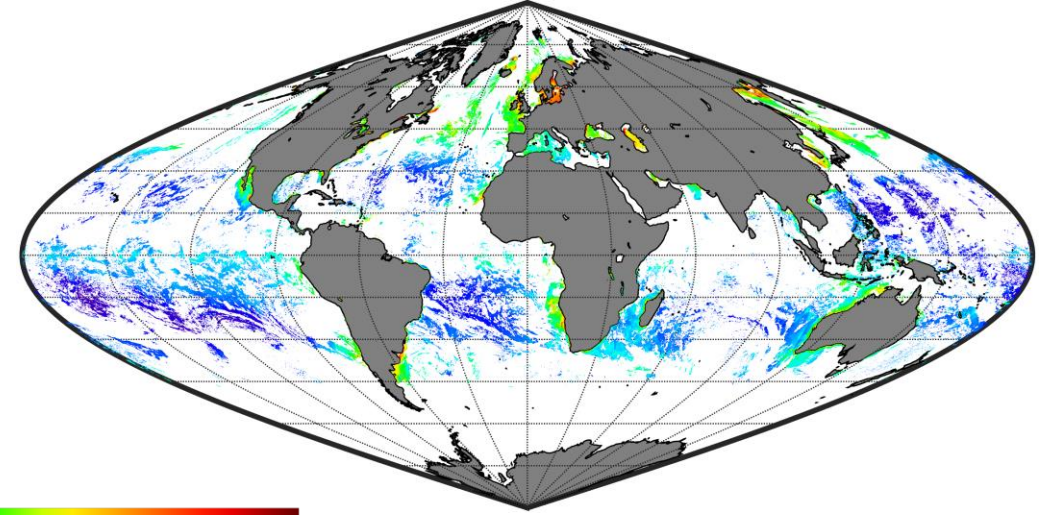
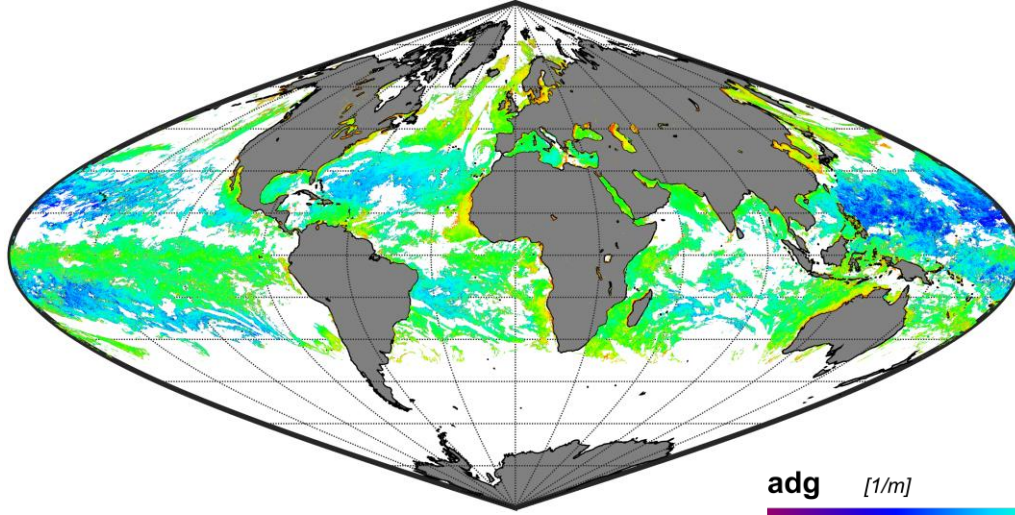

bbp443

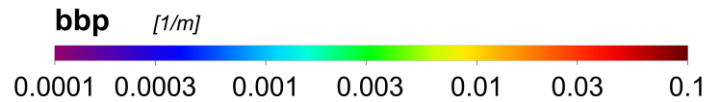
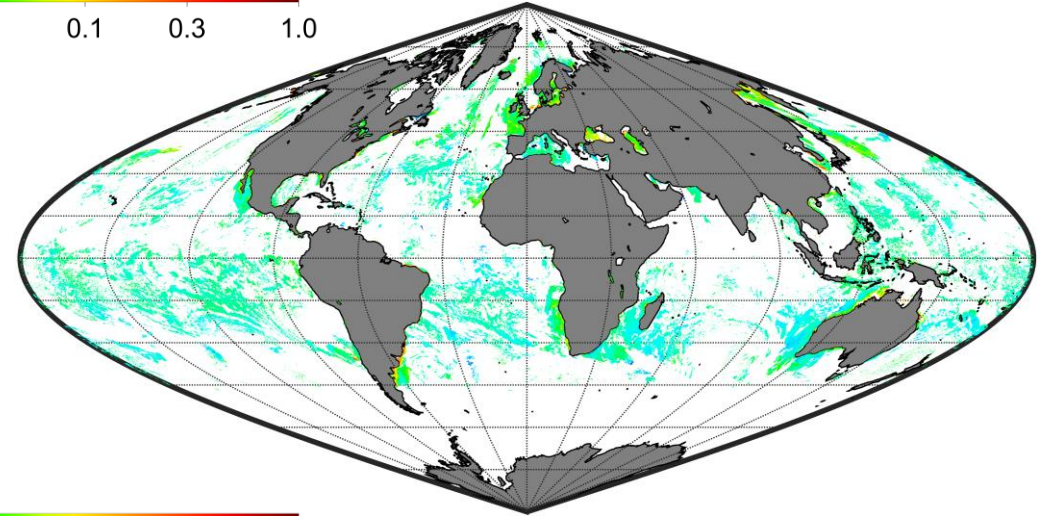
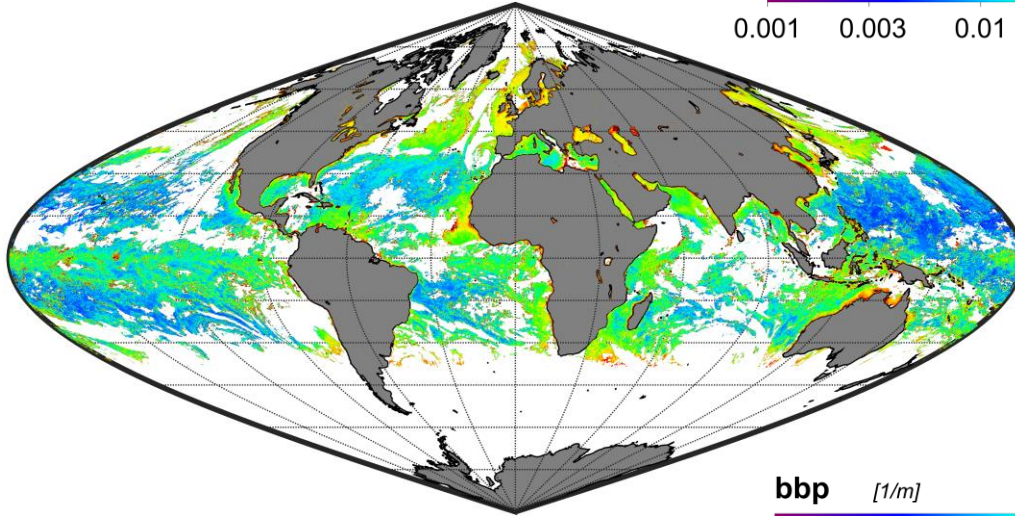

# EPIC Daily OC Products compared with MODIS/VIIRS (05/23/2018)

➤ **Quantitative comparison** between EPIC and MODIS/VIIRS daily ocean color products **shows very good agreement.**

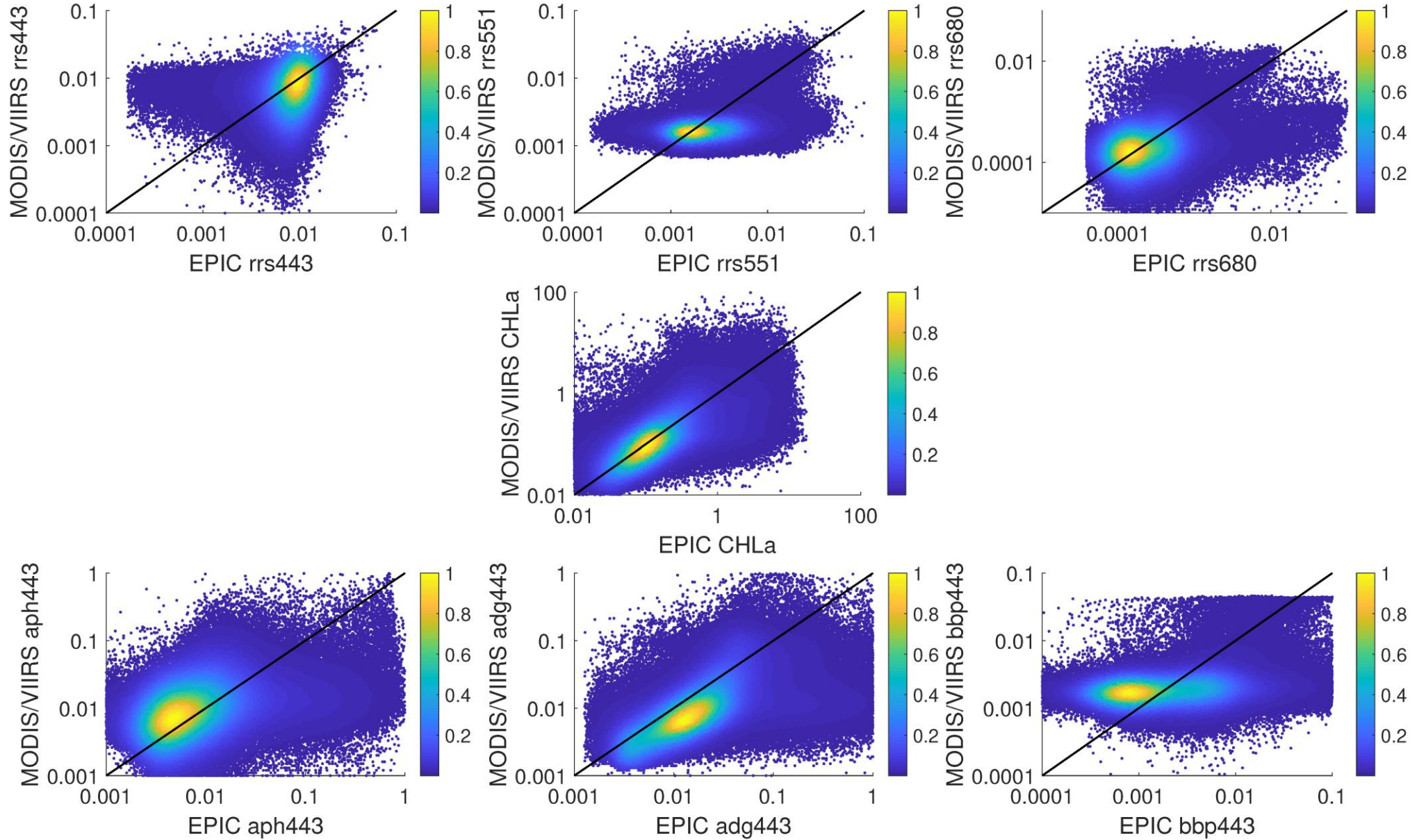



# EPIC Daily AOD (551nm) values from **MLNN** compared with **MODIS** (05/23/2018)

- The daily AOD retrieval from EPIC using MLNN AC shows **much better spatial coverage** than MODIS retrieval.
- The daily AOD retrieval from EPIC using MLNN AC shows **better resolution** than MODIS 1° X 1° products.
- **Quantitative comparison** between EPIC and MODIS daily AOD products shows **good agreement**.

**MLNN** daily composition

**MODIS** daily composition

AOD  
551nm

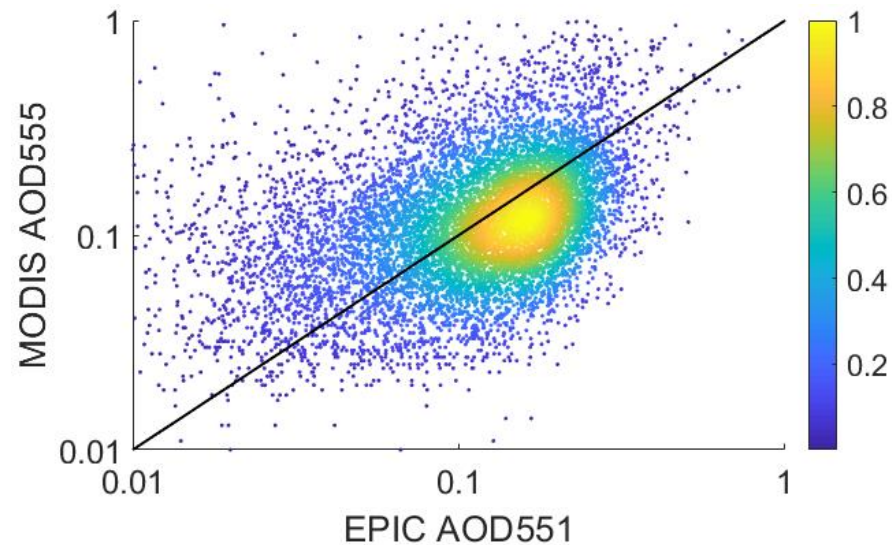
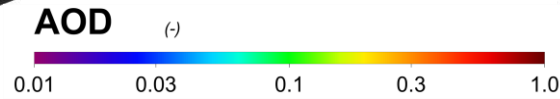
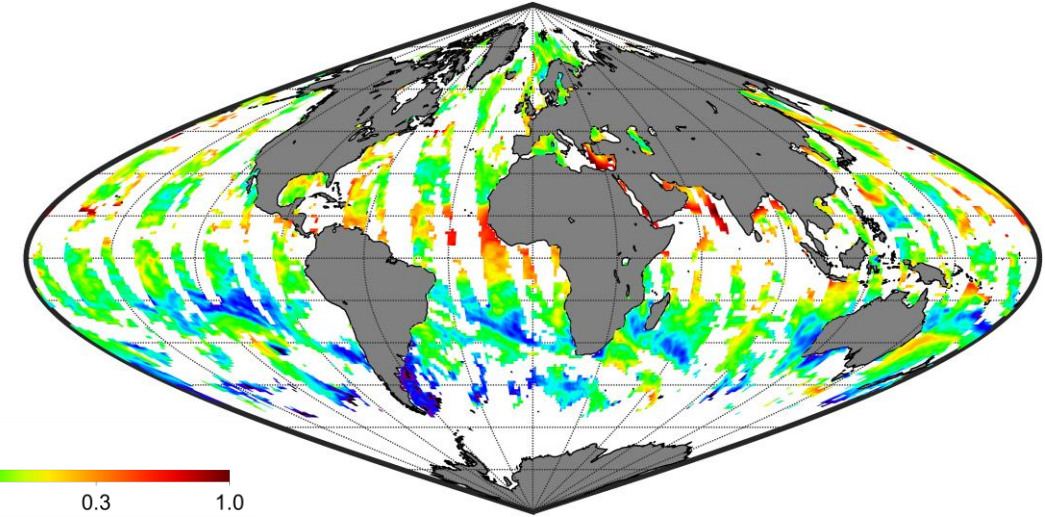
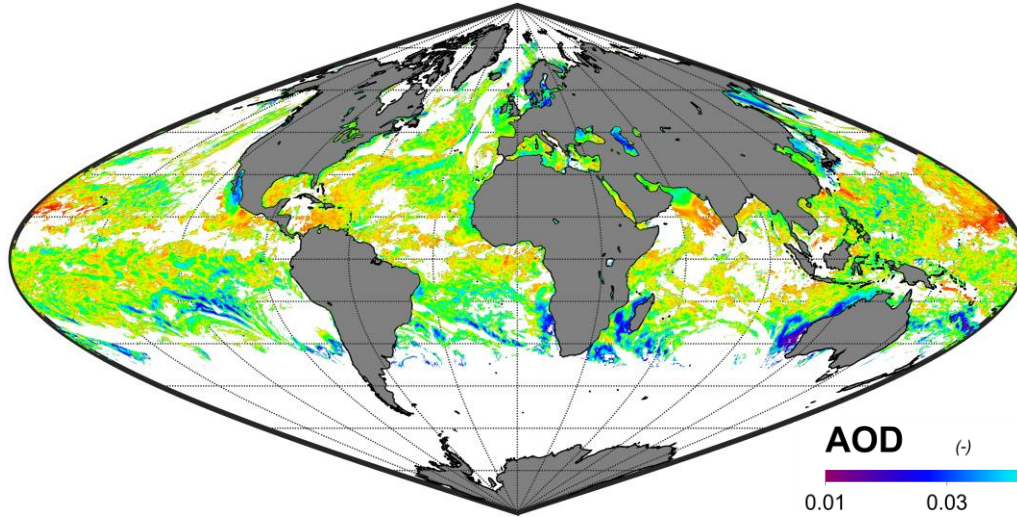

# Summary

- The **DSCOVER/EPIC** sensor has **high temporal resolution** which is suitable for capturing short-term variations in **aerosol loading** and the marine ecosystem, and its **daily global coverage** makes it suitable to investigate any area of interest. Despite the low spatial resolution, **EPIC products** are suitable for **global and regional studies** which can reasonably address some of the “Most Important” and “Very Important” Science and Applications objectives in the 2017-2027 Decadal Survey.
- Current AC algorithms for EPIC have issues in water areas (i.e. no distinction between surface and water body signals, negative reflectances, inaccurate cloud masks) and standard AC algorithms designed for ocean color (OC) sensors are not applicable to EPIC due to lack of required NIR and SWIR bands.
- We have redesigned our OC-SMART MLNN AC algorithm for EPIC based on its unique band configuration. The current Level-2 products include:
  - normalized remote sensing reflectances ( $R_{rs}$ ) at 388, 443, 551, 680, and 780 nm,
  - aerosol optical depth (AOD) at 388, 443, 551, 680, and 780 nm,
  - Chlorophyll\_a concentration (CHLa),
  - absorption by phytoplankton (aph) at 388, 443, 551, 680, and 780 nm,
  - absorption by CDOM and detritus (adg) at 388, 443, 551, 680, and 780 nm,
  - particulate backscattering (bbp) at 388, 443, 551, 680, and 780 nm,
  - Cloud mask results over water.
- The “raw” OC products have the same spatial resolution as the EPIC level 1B data and daily OC products is converted on to a 10 km X 10 km sinusoidal grid.
- A comparison of OC and AOD products retrieved from EPIC using our OC-SMART MLNN AC algorithm and those retrieved from the MODIS and VIIRS sensors using standard AC algorithms show a very good agreement over open ocean areas.
- Daily composition of the EPIC OC and AOD products produced by the MLNN AC algorithm shows a significant increase of spatial coverage compared with the OC and AOD products merged from the MODIS and VIIRS sensors.

# Future Work

- Include large solar and sensor viewing angles in our radiative transfer simulations to improve the performance of our MLNN AC algorithm at the edges of the EPIC images.
- Improve the performance of the CHLa algorithm by including more field measurements for validation.
- Further improve the ocean IOP MLNN algorithm (fine tuning the parameters based on field measurements).
- Apply new machine learning based cloud mask algorithm to improve cloud screening.
- Improve the vicarious calibration for EPIC data in both open ocean and coastal/inland water areas.
- Improve the AOD retrieval by including aerosol models from OPAC 4.0 dataset.
- Validate aerosol and ocean color products using ground-based measurements (AERONET-OC, SeaBASS databases) and cross validate with current ocean color sensor retrievals.

## Reference:

- Y. Fan, W. Li, C. K. Gatebe, C. Jamet, G. Zibordi, T. Schroeder and K. Stamnes, Atmospheric correction over coastal waters using multilayer neural networks, Remote Sensing of Environment, Vol. 199, p218-240, (2017). DOI: 10.1016/j.rse.2017.07.016.
- N. Chen, W. Li, C. Gatebe, T. Tanikawa, M. Hori, R. Shimada, T. Aoki, & K. Stamnes, New neural network cloud mask algorithm based on radiative transfer simulations, Remote Sensing of Environment, Vol 219, p62-71, (2018). DOI: 10.1016/j.rse.2018.09.029.
- Stamnes, K., B. Hamre, S. Stamnes, N. Chen, Y. Fan, W. Li, Z. Lin, and J. J. Stamnes, Progress in forward-inverse modeling based on radiative transfer tools for coupled atmosphere-snow/ice-ocean systems: A review and description of the AccuRT model, Applied Sciences, 8, 2682, 2018

**Thank you!**

**Questions?**